

Vapor Pressure Sensor for Vent Stacks

Installation Guide



Notice

Veeder-Root makes no warranty of any kind with regard to this publication, including, but not limited to, the implied warranties of merchantability and fitness for a particular purpose.

Veeder-Root shall not be liable for errors contained herein or for incidental or consequential damages in connection with the furnishing, performance, or use of this publication.

Veeder-Root reserves the right to change system options or features, or the information contained in this publication as approved by ARB.

This publication contains proprietary information which is protected by copyright. All rights reserved. No part of this publication may be modified or translated to another language without the prior written consent of Veeder-Root. Contact TLS Systems Technical Support for additional troubleshooting information at 800-323-1799.

DAMAGE CLAIMS / LOST EQUIPMENT

Thoroughly examine all components and units as soon as they are received. If any cartons are damaged or missing, write a complete and detailed description of the damage or shortage on the face of the freight bill. The carrier's agent must verify the inspection and sign the description. Refuse only the damaged product, not the entire shipment.

Veeder-Root must be notified of any damages and/or shortages within 30 days of receipt of the shipment, as stated in our Terms and Conditions.

VEEDER-ROOT'S PREFERRED CARRIER

1. Contact Veeder-Root Customer Service at 800-873-3313 with the specific part numbers and quantities that were missing or received damaged.
2. Fax signed Bill of Lading (BOL) to Veeder-Root Customer Service at 800-234-5350.
3. Veeder-Root will file the claim with the carrier and replace the damaged/missing product at no charge to the customer. Customer Service will work with production facility to have the replacement product shipped as soon as possible.

CUSTOMER'S PREFERRED CARRIER

1. It is the customer's responsibility to file a claim with their carrier.
2. Customer may submit a replacement purchase order. Customer is responsible for all charges and freight associated with replacement order. Customer Service will work with production facility to have the replacement product shipped as soon as possible.
3. If "lost" equipment is delivered at a later date and is not needed, Veeder-Root will allow a Return to Stock without a restocking fee.
4. Veeder-Root will NOT be responsible for any compensation when a customer chooses their own carrier.

RETURN SHIPPING

For the parts return procedure, please follow the appropriate instructions in the "General Returned Goods Policy" pages in the "Policies and Literature" section of the Veeder-Root **North American Environmental Products** price list. Veeder-Root will not accept any return product without a Return Goods Authorization (RGA) number clearly printed on the outside of the package.

INSTALLATION IN THE STATE OF CALIFORNIA

Please refer to the California Air Resources Board Vapor Recover Certification Phase II EVR Executive Order web site (www.arb.ca.gov/vapor/eo-evrphasell.htm) for the latest manual revisions pertaining to Executive Order VR 203 (VST Phase II EVR System) and VR 204 (VST Phase II EVR System Including ISD System).

©Veeder-Root 2013. All rights reserved.

Introduction

Contractor Certification Requirements 1
 Product Marking Information 1
 Related Documents 1
 Safety Warnings 3
 Safety Symbols 3
 Related Manuals 4
 Before You Begin 4
 Veeder-Root Parts 5
 Tools Required 7

Vapor Vent Stack Installation 8

Figures

Figure 1. Locating Pressure Sensor Enclosure in Vapor Vent Stack9
 Figure 2. Mounting Pressure Sensor Assembly onto Composite Panel 11
 Figure 3. Field wiring Pressure Sensor - Observe Polarity 12
 Figure 4. Epoxy sealing field wiring 12

Tables

Table 1. Pressure Sensor Installation Kit Form Number 861190-00X
 for UL/cUL approved pressure sensor5
 Table 2. Kit - Pressure Sensor Drying Tube (P/N 330020-717)5
 Table 3. Kit - Vapor Pressure Sensor Site Start-Up Install ISD (P/N 330020-715) .5
 Table 4. Kit - Universal Enclosure (P/N 330020-716)6

Introduction

A Vapor Pressure Sensor monitors the pressure in a vapor containment system located at a product fueling site. The purpose of this sensor is to detect pressure leakage as well as overpressure conditions that are both considered vapor containment faults. To accomplish this, the pressure sensor is installed the vapor vent stack.

Reference Figure 1 and Figure 2 in this manual. Each Vapor Vent Line must have an enclosure with the Vapor Pressure Sensor mounted inside. Additional customer supplied hardware is required to complete this type of vapor monitoring installation.

Contractor Certification Requirements

Veeder-Root Contractor Certification Requirements	Installer Certification ⁶	ATG Technician Certification ⁷	VR Vapor Products Certification ⁸
Install ¹ ISD	X	X	X
Install PMC	X	X	X
Install CCVP	X	X	X
Install Wireless ISD/PMC	X	X	X
Installation Checkout ²		X	X
ATG Startup ³ / Training ⁴ / Service ⁵		X	X
ISD Startup / Training / Service			X
PMC Startup / Training / Service			X
CCVP Startup / Training / Service			X
Wireless ISD/PMC Startup / Training / Service			X
Install Pressure Sensor (ATG)	X	X	X
Maintain Pressure Sensor (ATG)		X	X
Calibrate Pressure Sensor (ATG)		X	X
Clear ATG Pressure Sensor Alarm (ATG)		X	X
Clear ISD/PMC Alarms (ISD/PMC)			X
¹ Perform wiring and conduit routing; equipment mounting ² Inspect wiring and conduit routing; equipment mounting ³ Turn power on, program and test the systems ⁴ Provide supervised field experience in service techniques and operations ⁵ Troubleshoot and provide routing maintenance		⁶ UST Monitoring Systems – Installer (Level 1) ⁷ Certified UST Monitoring Technician ⁸ VR Vapor Products	

Warranty Registrations may only be submitted by selected Distributors. Certified installers are required to provide the GDF operator with the completed Equipment Warranty Notice, form 577013-868, for their records.

Product Marking Information

RELATED DOCUMENTS

Documents Required to Install Equipment



This intrinsically safe apparatus is only for use as part of a Veeder-Root Automatic Tank Gauging System (ATG Console with probes and sensors). To install intrinsically safe apparatus, use the specific control drawing that appears on the nameplate of the applicable associated apparatus (ATG Console):

Associated Apparatus	UL/cUL Control Drawing Number
TLS-350, TLS-350R	331940-011

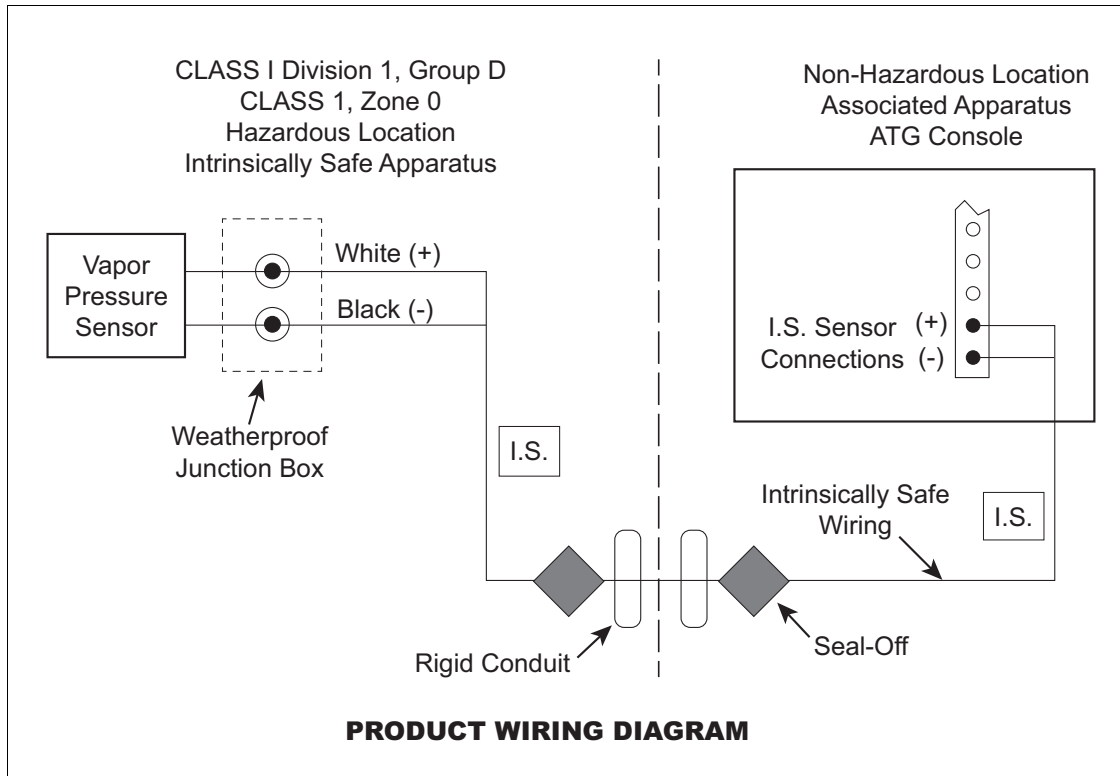
The control drawings contain information related to the correct installation of the overall intrinsically Safe System. This includes information such as maximum number of apparatus, specific apparatus allowed in the system, maximum cable lengths, references to codes, proper grounding and so on. Control drawings can be found on the accompanying Compact Disk (TECH DOCS CD) or on the internet at veeder.com under SUPPORT; VR TECHNICAL DOCUMENTS; DRAWINGS.









Product Label Contents

 <p>CL I, DIV. 1, GP.D CL I, ZONE 0 AEx ia IIA Ex ia IIA TC=T4 SECURITE INTRINSEQUE</p>	<p>I.S. CIRCUIT FOR HAZLOC SENSOR F/N 86119X-XXX S/N XXXXXX -40°C ≤ Ta ≤ +60°C MANUAL NO. 577014-019</p>	<p>2466 </p>
--	--	---

Safety Warnings





To protect yourself and your equipment, observe the following warnings and important information:







 WARNING	
    	<p>This product is to be installed in systems operating near locations where highly combustible fuels or vapors may be present.</p> <p>FAILURE TO COMPLY WITH THE FOLLOWING WARNINGS AND SAFETY PRECAUTIONS COULD CAUSE DAMAGE TO PROPERTY, ENVIRONMENT, RESULTING IN SERIOUS INJURY OR DEATH.</p> <ol style="list-style-type: none"> 1. Read and follow all instructions in this manual, including all safety warnings to protect yourself and others from serious injury, explosion, or electrical shock. 2. Comply with all applicable codes including: the National Electrical Code; federal, state, and local codes; and other applicable safety codes. 3. To protect yourself and others from being struck by vehicles, block off your work area during installation or service. 4. Do not alter or modify any component or substitute components in this kit. 5. Warning! Substitution of components may impair intrinsic safety. 6. Field wiring to the Sensor must not share a conduit with any non-intrinsically safe device's wiring. 7. Warning! To prevent ignition of flammable or combustible atmospheres, disconnect power before servicing. 8. Before installing or taking the unit into a hazardous area, earth the unit in a safe area to remove any static charge. Then immediately transport the unit to the installation site. Do not rub or clean the unit prior to installation. Cleaning is not required under normal service conditions. Do not rub or clean the unit after installation. If the unit is not fixed to a known earth point when installed, ensure that a separate earth connection is made to prevent the potential of a static discharge. When fitting or removing the unit, use of anti-static footwear or clothing is required. 9. Materials used in the construction of this device do not contain, by mass, more than 10% in total of aluminum, magnesium, zirconium and titanium or 7.5% in total of magnesium, titanium and zirconium.

NOTE Failure to install this product in accordance with its instructions and warnings will result in voiding of all warranties with this product.

Safety Symbols

The following safety symbols may be used throughout this manual to alert you to important safety hazards and precautions.

 <p>EXPLOSIVE Fuels and their vapors are extremely explosive if ignited.</p>	 <p>FLAMMABLE Fuels and their vapors are extremely flammable.</p>
 <p>ELECTRICITY High voltage exists in, and is supplied to, the device. A potential shock hazard exists.</p>	 <p>TURN POWER OFF Live power to a device creates a potential shock hazard. Turn Off power to the device and associated accessories when servicing the unit.</p>

 <p>WARNING Heed the adjacent instructions to avoid damage to equipment, property, environment or personal injury.</p>	 <p>USE SAFETY BARRICADES Unauthorized people or vehicles in the work area are dangerous. Always use safety cones or barricades, safety tape, and your vehicle to block the work area.</p>
 <p>WEAR EYE PROTECTION Wear eye protection when working with pressurized fuel lines or epoxy sealant to avoid possible eye injury.</p>	 <p>INJURY Careless or improper handling of materials can result in bodily injury</p>
 <p>GLOVES Wear gloves to protect hands from irritation or injury</p>	 <p>READ ALL RELATED MANUALS Knowledge of all related procedures before you begin work is important. Read and understand all manuals thoroughly. If you do not understand a procedure, ask someone who does.</p>

Related Manuals

IOM19 VR-203 and VR-204 TLS RF Wireless 2 System (W2) Installation and Maintenance Guide
576013-879 TLS-3XX Site Prep Manual

Before You Begin

- Review and comply with all the health and safety warnings in the installation manuals and any other national or local requirements.
- When direct wiring to a TLS console, a 2-conductor, 18 AWG, or equivalent, shielded cable must be installed in intrinsically safe conduit from the dispenser or from the vapor vent stack to the TLS console.
- The Pressure Sensor must be installed in a VERTICAL position with the sensing port pointing down. The Tygon tubing connecting the vapor pressure sensor to the drying tube must be attached to the down port of the drying tube. **The 'up' port must be left open to atmosphere.**
- For all connections requiring sealant, use only UL classified yellow Gas/TFE Teflon tape.
- Customer supplied pipe and pipe fittings shall be standard full-weight (ASTM Schedule 40, or equivalent) wrought iron or steel.
- Customer supplied copper tubing shall be soft tempered, 1/4-inch O.D., with a minimum wall thickness of 0.0265 inches.
- Pipe threads shall be in accordance with the Standard for Pipe Threads, General Purpose (Inch) ANSI/ASME B1.20.1-1983, or equivalent.

Veeder-Root Parts

Table 1. Pressure Sensor Installation Kit Form Number 861190-00X for UL/cUL approved pressure sensor

Item	Qty.	Description	P/N
1	1	Pressure sensor assembly	8611X0-X0X
2	1	Warranty registration form	576047-146
3	1	Warranty card	577013-868
4	1	Union 62CA-4, brass 1/4" tube size	514100-431
5	1	Sealing pack	514100-304
6	2	Wire nut	576008-461
7	2	Tie wrap	510901-337
8	1	Shim	332061-001
9	1	Installation manual	577014-019
10	1	Kit - vapor pressure sensor drying tube	330020-717

Table 2. Kit - Pressure Sensor Drying Tube (P/N 330020-717)

Item	Qty.	Description	P/N
1	1	Drying tube - non-indicating desiccant	514100-424
2	36"	Tubing - Tygon fuel and lube	514110-425
3	4	Tie wrap	510901-337
4	2	Self-adhesive mount - tie wrap	576008-437

Table 3. Kit - Vapor Pressure Sensor Site Start-Up Install ISD (P/N 330020-715)

Item	Qty.	Description	P/N
1	4	Male connector 68CA-4-4, brass 1/4" tube to 1/4" pipe	514100-430
2	1	Plug 59CA-4, brass 1/4" tube size	514100-432
3	1	Universal Mount Kit (assorted screws, clamps, brackets, bolts, washers and nuts)	330020-012
4	1	Cord grip	331028-001
5	1	Ball valve, 3-way, 1/4"	576008-649
6	36"	Tube - soft copper, 1/4" OD	332151-001

Table 3. Kit - Vapor Pressure Sensor Site Start-Up Install ISD (P/N 330020-715)

Item	Qty.	Description	P/N
7	2	Male elbow 169CA-4-4, brass 1/4" tube to 1/4" pipe	579066-001
8	1	Bulkhead union 62CABH-4, brass 1/4" tube size	514100-476
9	2	Washer, 0.469 x 1.125 x 0.063", zinc	510904-573
10	1	Tube - copper, 1/4" OD, short S bend	333006-001

Table 4. Kit - Universal Enclosure (P/N 330020-716)

Item	Qty.	Description	P/N
1	1	Enclosure, NEMA 4X-modified	333004-001
2	1	Vent plug, porous, flanged, 0.17 x 0.42"	514100-477
3	1	Label - Veeder-Root	333042-001
4	1	Label - eVRgreen	333041-001
5	1	Panel, composite, modified	333005-001
6	1	Cord grip bushing	330787-004
7	2	Conduit clamp, 3", steel, std duty	514100-482
8	1	Conduit hub	576010-715
9	2	Hex bolt - steel, 1/4-20 x 0.75"	026-620-1
10	2	Washer, flat, 1/4", zinc	514100-374
11	2	Hex nut w/lock washer, 1/4-20	511000-251
12	2	Conduit clamp, 2", steel - std duty	514100-478
13	1	Fitting, cap plug	027-213-1
14	1	Mounting bracket, Receiver	332315-001
15	1	Mounting bracket, Battery	332295-002
16	1	Panel nut, 7/8-16 x 1/4 thick	514100-475
17	6	Screw, #10-32 x 1/2 Taptite	510500-400
18	1	Label - universal enclosure kit	333263-001
19	1	Group - cord grip, 1/2" NPT	331028-001
20	1	Cord grip bushing	330787-002

Tools Required

1. Wrenches suitable for tightening tubing/pipe fittings.
2. Necessary pipe fitter's equipment (including tube bending and threading equipment as needed) and a non-hazardous work space suitable to modify the vapor vent stack for Vapor Pressure Sensor installation.
3. Torx bit for tamper-resistant screws (V-R P/N 330020-635).

NOTE: this bit is required to open and close the enclosure door.

Vapor Vent Stack Installation

1. Before installing this device, perform all required safety procedures to gain access inside the vapor vent stack.
2. Determine which vapor vent stack line is closest to the tank being monitored. Select this line for the addition of the pressure sensor.
3. Locate a suitable port in an existing Schedule 40 piping fitting (tee, cross, etc.) or plumb a suitable Schedule 40 pipe fitting (tee, cross, etc.) into the vapor vent stack line (maximum length of copper tubing limited by dimension in Figure 1).
4. Install the vapor pressure sensor (item 1 in Table 1) vertically onto the center of the composite panel (item 5 in Table 4). Insert the sensor in the 2-inch conduit clamp using necessary bolts, nuts, and washers included in the universal mounting kit (item 3 of Table 3). Be sure the top symbol on the panel is facing upwards (see Figure 2). Wrap the rubber shim (item 8 in Table 3) around the sensor before inserting it into the clamp. Also make sure the sensor cable outlet is facing up and the pressure sensing port tube in the base of the sensor is facing down. Locate the pressure sensor in the clamp, but leave the conduit clamp screw somewhat loose for later sensor height adjustment.
5. Install two 169CA-4-4 male elbows (item 7 in Table 3) into each end of the 3-way calibration valve (item 5 in Table 3) as shown (see Figure 2).
6. Install one 68CA-4-4 male connector (item 1 in Table 3) into the center port of the 3-way calibration valve, and then directly attach it to the vapor pressure sensor inlet port (center) (see Figure 2).
7. Screw the 59CA-4 plug (item 2 in Table 3) onto the left port's male elbow (see Figure 2).
8. Install the two plastic enclosure mounting plates to the back of the enclosure. Use the four short flat-head screws included in the enclosure hardware bag.
9. Install the composite panel into the enclosure (item 5 in Table 4) such that the sensor cable outlet is facing up and the pressure sensing port tube in the base of the sensor is facing down. The top symbol on the panel should be facing upward. Use the four short screws included in the enclosure hardware bag.
10. Make sure that the white flanged porous vent (factory installed - item 2 in Table 4) is still securely installed into the hole in the bottom of the enclosure (see Figure 2).
11. Insert the S-bend 1/4" OD copper tube (item 10 in Table 3) into the right-side male elbow of the 3-way calibration valve, but do not fully tighten the compression nut (see Figure 2).
12. Locate the 62CABH-4 bulkhead union (item 8 in Table 3) and remove the compression nut and the adjustable nut then place a large washer (item 9 in Table 3) against the fixed, integral body nut. Slide the compression nut that was removed onto the bottom portion of the S-bend tube.
13. Partially insert the bulkhead union into the bottom center hole in the enclosure. Slide a large washer over the body, and thread the adjustable nut back onto the body.
14. Insert the bottom portion of the S-bend tube into the bulkhead union and fully tighten the bulkhead union adjustable nut against the large washer and enclosure wall. Adjust the pressure sensor vertically in the shim / conduit clamp to make sure the S-bend tube is fully inserted into the union and male elbow.
15. Fully tighten the compression nuts to connect the S-bend tube to the union and to the male elbow. Tighten the sensor conduit clamp screw to secure the sensor in its final vertical position (see Figure 2).

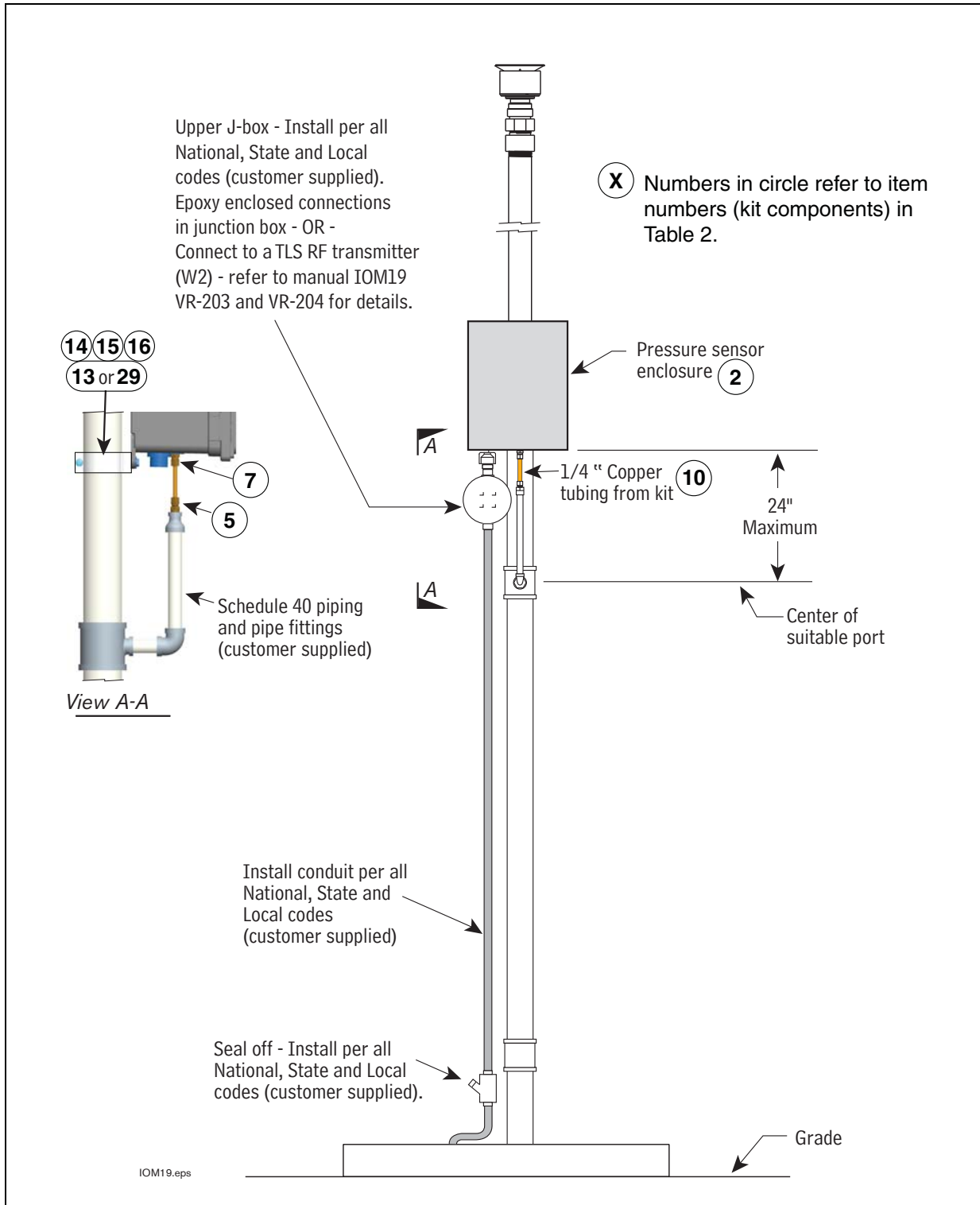

Figure 1. Locating Pressure Sensor Enclosure in Vapor Vent Stack

16. Get the contents of the pressure sensor drying tube kit (Table 2). Thread a tie wrap (item 3) through the slots in each of the self-adhesive mounts (item 4). Place the top mount against the large cap on one end of the tube and tighten the tie wrap until it is against the tube cap but you can still rotate the tube. Place the second mount against the other end cap of the tube, again pulling the tie wrap through the mount until it is against the tube cap but you can still rotate the tube.

Remove the two soft plastic seals from each end port of the drying tube. Get the Tygon tubing (item 2) from the kit and attach one end of the tubing to one end of the drying tube. Slide the tubing onto the drying tube as far as you can (snug). Referring to Figure 2, position the drying tube vertically in the enclosure with the open port of the tube up, and estimate the length needed to loop from the bottom of the drying tube up to the vent port (off center) of the Vapor Pressure Sensor. Cut the Tygon tubing at the estimated length (approximately a foot or so). Remove the paper cover from the self-adhesive base of the two tie wrap mounts and stick the drying tube to the inside of the enclosure as shown in Figure 2. Pull each of the tie wraps snug and cut off the excess. Attach the other end of the Tygon tubing to the vent port (off center) of the Vapor Pressure Sensor. NOTE: the upper port of the drying tube must remain open and be oriented up as shown in Figure 2.

17. Mount the plastic enclosure onto the vapor vent stack or suitable rigid structure ABOVE the vapor vent stack port using two conduit clamps (for 2" or 3" pipe), bolts, nuts, and washers included, or use other customer supplied suitable mounting hardware (Example: Unistrut®). Leave the mounting hardware somewhat loose for later enclosure height adjustment (see Figure 1).
18. Measure, fabricate, and install customer supplied pipe and pipe fittings between the vapor vent stack port and within a few inches of the bulkhead union in the bottom of the enclosure.
19. Install one 68CA-4-4 male connector (item 1 in Table 3) onto the top of the new pipe (see View A-A, Figure 1).
20. Measure, fabricate, and install 1/4" OD copper tubing (item 6 in Table 3) between the bulkhead union and the male connector. Adjust the enclosure vertically on vent pipe to make sure the copper tube is fully inserted into the bulk head union and male connector.
21. Fully tighten the compression nuts to secure the fabricated tube to the bulkhead union and to the male connector. Tighten the enclosure mounting hardware to secure the enclosure in its final vertical position.

Note: **Important!** All plumbing's pitch to drain should be 1/4" vertical per 12" horizontal to eliminate any potential liquid traps.

22. Make sure the valve's handle is set to connect the sensor to the vapor vent stack as shown in Figure 2 and not to the capped (vent) port.
23. Install two tamper-resistant screws from the enclosure hardware bag into the two holes on the enclosure door (if not already installed) using a Torx bit for tamper-resistant screws. Discard any remaining items in the enclosure hardware bag.
24. When direct wiring to a TLS console, install 1/2" electrical conduit from the conduit hub in the bottom of the enclosure to the customer supplied weather-proof junction box (see Figure 1). For wireless installations, using the TLS RF, Steps 24 - 27 are not required.
25. Route the cable from the pressure sensor to the junction box under the enclosure. Observing polarity, connect the sensor wiring to the field wiring from console and cap with wire nuts (see Figure 1).
26. Seal wire nuts in epoxy sealant following the instructions in Figure 4.
27. Push the epoxy sealed bag into the junction box. Replace and tighten the junction box cover.
28. Terminate field wiring into TLS 350R console and connect to a Smart Sensor Module. Note: observe polarity! The cable length between the console and sensor must not exceed the distance stated in the applicable console's Site Prep manual.

29. After the Pressure Sensor is installed, pressurize the tank ullage space and vapor piping to at least 2 inches WC and test for leaks using leak detection solution.
30. Close the enclosure door and secure by threading the tamper-resistant screws into the enclosure body using a Torx bit for tamper-resistant screws.
31. Affix the eVRgreen label (item 4 in Table 4) to the enclosure door as desired.

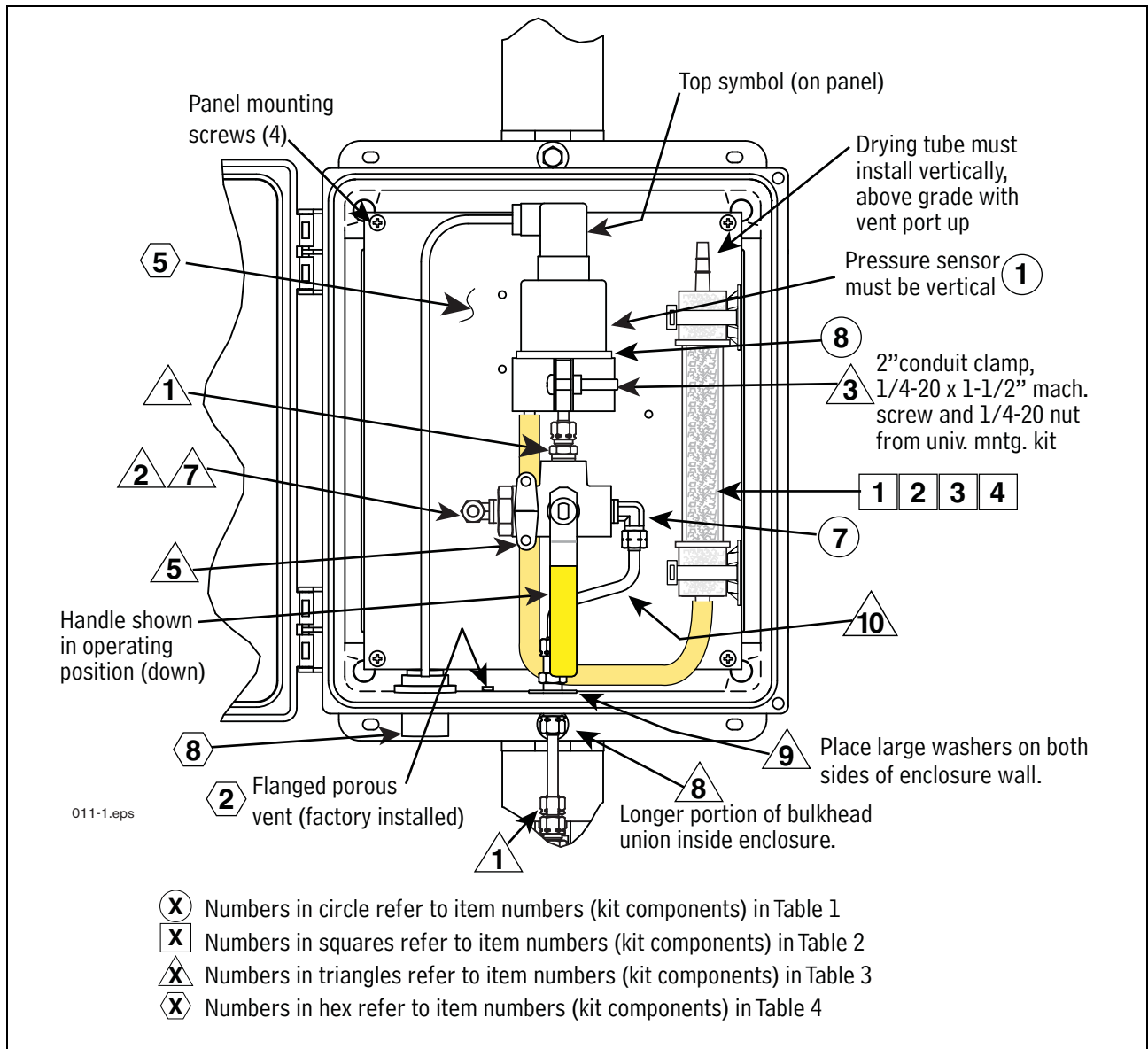

Figure 2. Mounting Pressure Sensor Assembly onto Composite Panel

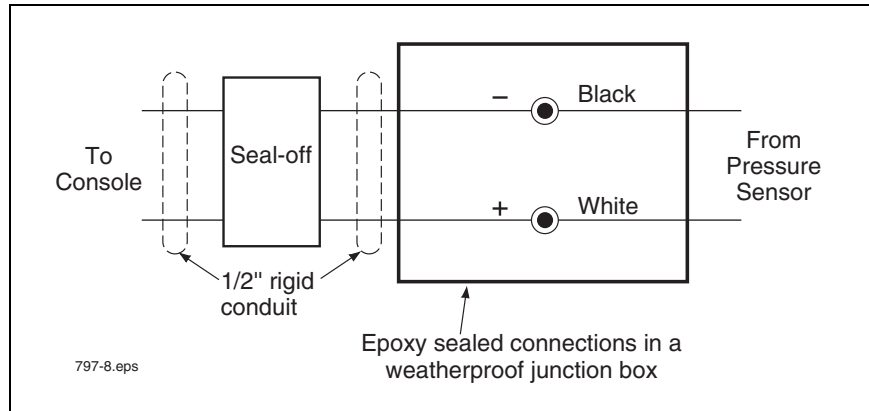

Figure 3. Field wiring Pressure Sensor - Observe Polarity

A

B

C

797-6.eps

Instructions:

NOTE: When temperature is below 50°F (10°C), keep resin in a warm place prior to mixing (e.g., in an inside pocket next to body).

1. Open epoxy sealant package, and remove resin pak.
2. Holding resin pak as shown in A, bend pak along long length.
3. As shown in B, firmly squeeze the RED SIDE of the resin, forcing it through the center seal and into BLACK SIDE.
4. Mix thoroughly to a uniform color by squeezing contents back and forth 25-30 times.
5. Squeeze mixed, warm resin into one end of bag and cutoff other end.
6. Slowly insert wiring connections into sealing pack until they fit snugly against the opposite end as shown in C.
7. Twist open end of bag and use tie wrap to close it off and position the tie wrapped end up until the resin jells.

CAUTION: Epoxy sealant is irritating to eyes, respiratory system, and skin. Can cause allergic skin reaction. Contains: epoxy resin and Cycloaliphatic epoxy-carboxylate.

Precautions: Wear suitable protective clothing, gloves, eye, and face protection. Use only in well ventilated areas. Wash thoroughly before eating, drinking, or smoking.

NOTE: Not required for wireless installations!

Figure 4. Epoxy sealing field wiring

