

**WAYNE-DRESSER 1V, 2V, 3V, & 4V™ SERIES DISPENSER  
RETROFIT for HEALY SYSTEMS, INC.  
MODEL VP1000  
VAPOR RECOVERY ASSIST SYSTEM  
(KIT Z084)**

**OUTLINE**

**Notice: USE THIS PROCEDURE IF CONVERTING A BALANCE VAPOR RECOVERY SYSTEM TO A HEALY VAPOR RECOVERY ASSIST SYSTEM**

This Manual is to be used for new, replaced, retrofitted, or reconditioned dispensers/pumps.

- 1. Purpose**
  - 2. Safety**
  - 3. Models Covered**
  - 4. Parts Lists**
  - 5. Tools Required**
  - 6. Dispenser Access**
  - 7. Survey Scope of Work**
  - 8. Installing The Healy VP1000 System**
  - 9. Installing The Sealed Nipple Assembly**
  - 10. Wiring Inside The Electronics Compartment**
  - 11. Connecting Healy Systems Dispensing Equipment**
  - 12. VP1000 Theory Of Operation**
  - 13. Testing The System**
  - 14. Trouble Shooting The VP1000**
  - 15. VP1000 Vane & Rotor Service & Replacement Guide**
- Start-up / New Installation / Warranty / Annual Testing Form**

## 1. PURPOSE:

This procedure describes the tools, methods and skill levels required to install a Healy Systems, Inc. Model VP1000 Vapor Recovery pump in vapor ready Wayne-Dresser™ 1V, 2V, 3V, & 4V series gasoline dispenser. Only Healy trained and certified contractors will be able to perform these retrofits or warranty will be void. The installer shall be a skilled petroleum technician and thoroughly familiar with the requirements of State, Federal and local codes for installation and repair of gasoline dispensing equipment. Also, they shall be aware of all the necessary safety precautions and site safety requirements to assure a safe and trouble free installation. NOTE: All electrical and hydraulic plumbing fittings referred to in these instructions must be UL “listed” or “recognized” for the purpose.

**Note:** Installations of vapor piping into the inlet side of the vacuum pump should be sloped such that the natural flow direction is toward the vacuum pump. However, it is permissible to have a piping slope tilted away from the vacuum pump provided that all other applicable tests (Dispenser integrity and V/L) meet the specifications outlined in the appropriate section of the Executive Order and **CARB Approved Installation, Operation and Maintenance Manual**.

**Note:** For installations with In-Station Diagnostics (ISD), the vapor flow meter shall be installed on the down stream side of the vacuum pump. Every effort shall be made to install the vapor flow meter so that vapor piping between the vacuum pump and the vapor flow meter is sloped such that the natural flow direction is toward the vapor flow meter. However, it is permissible to have the piping slope away from the vapor flow meter provided that all other applicable tests (Dispenser integrity, V/L and ISD Operability) meet the specifications outlined in the appropriate section of the Executive Order and **CARB Approved Installation, Operation and Maintenance Manual**.

## 2. SAFETY:

Before installing the equipment, read, understand and follow:

- The National Electrical Code (NFPA 70)
- The Automotive and Marine Service Code (NFPA 30A)
- Any national, state and local codes that may apply.

The failure to install the equipment in accordance with NFPA 30A and 70 may adversely affect the safe use and operation of the system.

Accurate, sound installations reduce service calls: Use experienced, licensed contractors that practice accurate, safe installation techniques. Careful installation provides a sound troubleshooting framework for field repairs and can eliminate potential problems.

1. Read all instructions before beginning.
2. Follow all safety precautions:
  - Barricade the area.
  - Do not allow vehicles or unauthorized people in the area.

- ❑ Do not smoke or allow open flames in the area.
  - ❑ Do not use power tools in the work area.
  - ❑ Wear eye protection during installation.
3. Use circuit breakers for multiple disconnects to turn off power and prevent feedback from other dispensers.

**3. MODELS COVERED:**

Wayne 1V, 2V, 3V, & 4V™ series of blending and non-blending dispensers. The addition of the Healy Systems VP1000 to these dispensers will increase the current draw of the dispenser by 2 amps. Use the label supplied to note this change.

**4. PARTS LISTS: (See Photo A)**

- 1 VP1000 Vacuum Pump
- 1 1365A Wire Harness / MC100 Series Interface Module Assembly (for 3V) or
- 1 1363A Wire Harness / MC100 Series Interface Module Assembly (for 1V & 2V)

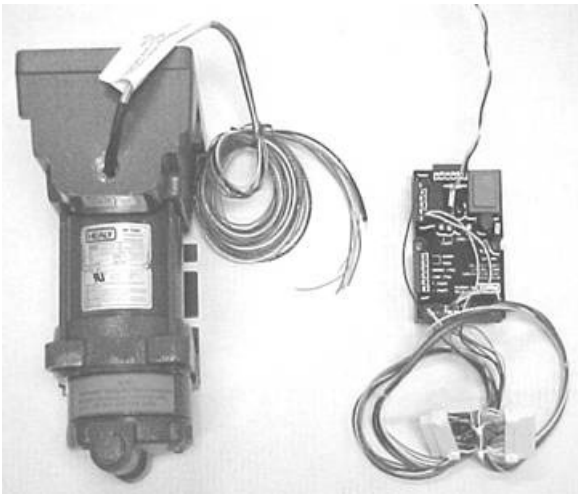

**PHOTO A**

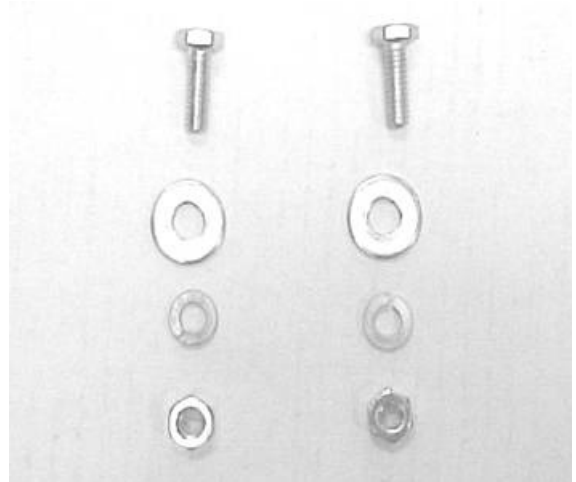

**PHOTO B**



**PHOTO C**

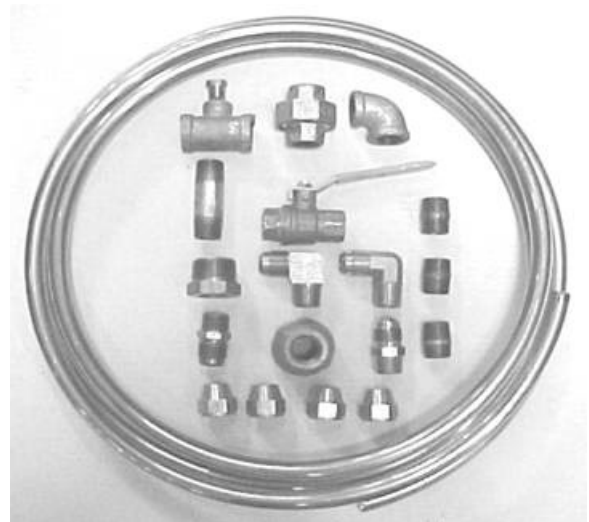

**PHOTO D**

### **HARDWARE KIT Z084H: (See Photo B)**

- 1 1/4-20 bolts, washers, lock washers and nuts.

### **ELECTRICAL KIT Z084E: (See Photo C)**

- |   |                                 |   |                                  |
|---|---------------------------------|---|----------------------------------|
| 7 | Wire nuts                       | 1 | 8-32 x 3/4" machine screw w/ nut |
| 1 | 3/4" electrical coupling        | 1 | #1346 potted conduit nipple      |
| 1 | #8 Ring tong terminal           | 1 | Notice label (p/n 1406)          |
| 1 | UL Listed label (p/n 1410)      | 1 | 1/2" electrical capped elbow     |
| 3 | 3/4" x 1/2" electrical bushing  | 1 | 1/2" electrical close nipple     |
| 1 | 1/2" electrical union           | 2 | 1/2" x 7" electrical nipple      |
| 1 | 1/2" x 4 1/2" electrical nipple | 1 | 1/2" electrical coupling         |
| 1 | Explosion proof 'J' box         | 1 | Current change label (p/n 1405)  |

### **VAPOR KIT Z084V: (See Photo D)**

- |     |                                |   |                                 |
|-----|--------------------------------|---|---------------------------------|
| 2   | 1/2" NPT x 5/8" straight flare | 1 | 1/2" x 1" NPT bell reducer      |
| 12' | 5/8" OD copper tube, type 'L'  | 1 | 1/2" x 1/4" x 1/2" reducing tee |
| 1   | 1/2" ball valve                | 1 | 1/4" pipe plug                  |
| 4   | 5/8" flare nuts                | 1 | 1" x 1/2" NPT reducing bush.    |
| 1   | 1/2" NPT ell galv.             | 1 | 1/2" NPT galv. union            |
| 1   | 1/2" NPT x 2-1/2" galv. nipple | 3 | 1/2" NPT galv. close nipples    |
| 2   | 1/2" NPT x 5/8" flare elbow    |   |                                 |

### **MATERIALS SUPPLIED BY INSTALLER:**

- ❑ Thread Sealing Compound – non-Setting, UL Classified for use on all tapered thread, non-electrical, plumbing fittings.
- ❑ Oil and gasoline compatible PTFE tape

### **5. TOOLS REQUIRED:**

- ❑ 1/2" or 3/8" ratchet set w/ sockets 1/4" through 9/16" + 3" extension
- ❑ 9" lineman's pliers
- ❑ Assorted open end wrenches 1/4" through 3/4"
- ❑ Wire cutters/strippers 18 AWG and 26 AWG
- ❑ 1-1/8" Greenlee type sheet metal punch
- ❑ Mechanical hand drill (egg-beater type)
- ❑ Assorted drill bits 1/16" through 7/16"

- ❑ Assorted screwdrivers (flat blade-one must be 1/8" wide and Phillips)
- ❑ 5/8" copper tube bending tool
- ❑ 5/8" copper tube flaring tool
- ❑ Copper tubing cutter
- ❑ Electrical multi-Oeter
- ❑ Small hand brush (1-1/2" thick, for clearing chips)
- ❑ 12" adjustable wrench
- ❑ 10" pipe wrench
- ❑ Tape measure
- ❑ Allen wrenches

## 6. DISPENSER ACCESS:

- ❑ Secure Dispenser Access keys from Station Management.
- ❑ Lock-out and tag-out all electrical power to dispenser being modified.
- ❑ Remove both lower dress panels.
- ❑ Remove side skin on the left side as viewed from the 'A' side ('J' box). This is the side where the 1" balance vapor pipe is installed.
- ❑ Open both upper doors to the electronics compartment.

## 7. SURVEY – Scope of Work: *Perform this step before beginning steps 8 thru 10.*

Read and familiarize yourself with the theory of operations sheet and wiring instructions for the VP1000 Vapor Pump. The installation of the pump is accomplished by rotating the motor mounting bracket bolting it to the dispenser frame on the same side as the electrical 'J' box in the free space on the left hand side, see photos E & F. From this survey, you will have an indication of where the vapor plumbing fittings need to go and where the electrical conduits need to be routed. The Healy potted conduit nipple is installed in the vapor barrier above the meters, in a 1 1/8" hole that is already available but is plugged. See Photo K and Section 9.

**CAUTION: ALL POWER TO DISPENSER UNDER MODIFICATION SHOULD BE COMPLETELY DISCONNECTED AND CAPPED OFF AT JUNCTION BOX TO AVOID UNINTENTIONAL FEEDBACK FROM OTHER DISPENSERS!!**



**Photo E**

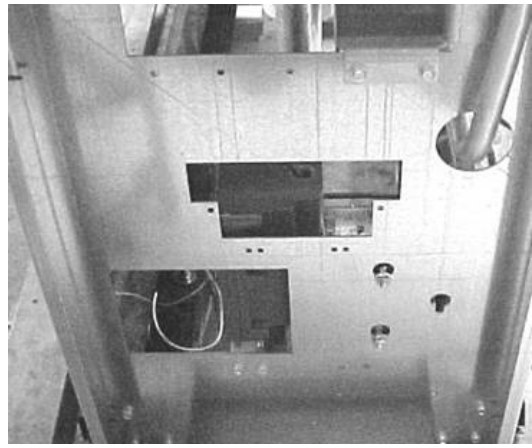

**Photo F**

## **8. INSTALLING THE HEALY VP1000 SYSTEM:**

- ❑ Locate the 1" vapor down pipe on the side of the cabinet and remove the 'U' bolt that secures the pipe to the cross rail in the hydraulics area.
- ❑ On the top of the down pipe, loosen the two flare nuts and release the two vapor pipes coming into the tee from each side of the dispenser. Caution: the pipe is now loose and could fall down, see photo G.
- ❑ Remove the pipe from the dispenser and remove the tee from the pipe. Save the tee, discard the pipe.
- ❑ Use pipe dope and install a 1" x 1/2" NPT reducer bushing into the branch of the tee.
- ❑ Install a 1/2" NPT x 5/8" straight flare fitting into the reducer installed above.
- ❑ Re-install the tee back into the dispenser with the branch facing downward and re-connect the vapor tubes removed earlier. Be sure to tighten the vapor tube flare nuts securely, see photo H.
- ❑ Get the VP1000 pump and looking from the front (pump end), remove the four screws holding the black mounting bracket to the motor and reposition the bracket 90° clockwise, then re-install the screws. This keeps the pump inlet in the correct "up" orientation when mounted in the cabinet, see photo E.
- ❑ Place two of the 1/4"- 20 mounting bolts, flat washers, lock washers and nuts loosely together and into the slots on the motor mounting base.
- ❑ On the left side of the cabinet ('A' side with 'J' Box), notice the three keyhole punch-outs, see photo F. Lift the motor and push the washer/nut combinations through from inside the cabinet to mount the motor tight to the side frame.

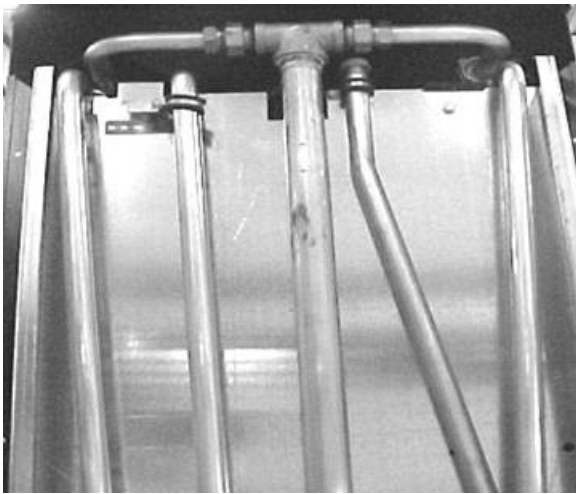

**Photo G**

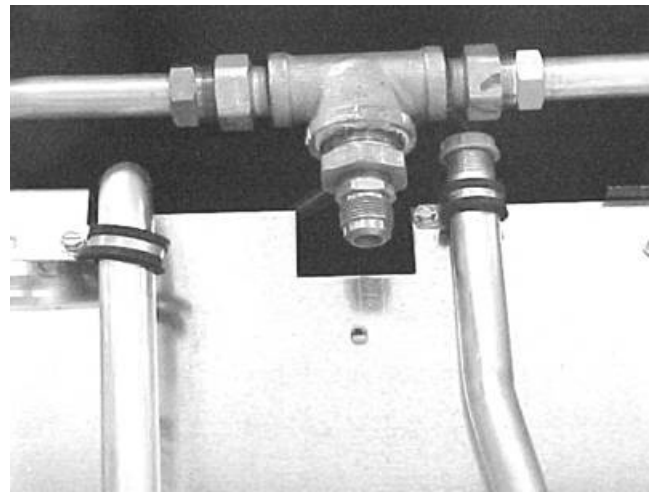

**Photo H**



**Photo I**

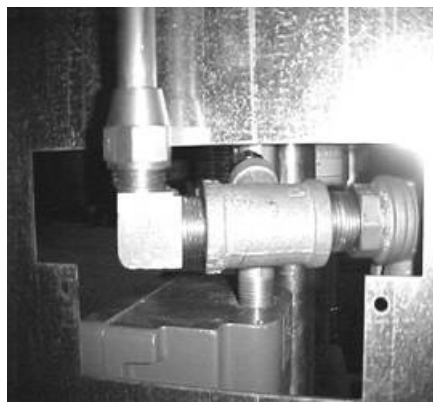

**Photo J**



**Photo K**

Use Oil and gasoline compatible PTFE tape on the following steps.

- ❑ Get the 1/2" galvanized union and thread a 1/2" galvanized close nipple into each end.
- ❑ Separate the union and install the end that does not have the nut on it into the inlet of the vacuum pump. To the other end of the union, assemble the 1/2" galvanized elbow and then a 1/2" x 2-1/2" galvanized nipple into the elbow, see photo I.
- ❑ To the nipple above, thread on the 1/2" ball valve so that when the handle is in the open position it faces you. Completely tighten the ball valve to be about 30° below horizontal to the right, see photo I.
- ❑ To the valve, install a 1/2" close nipple then the 1/2" x 1/4" x 1/2" reducing tee and completely tighten with the branch of the tee facing to the right when looking from the union end, see photo I.
- ❑ Install the 1/4" pipe plug into the reducing tee and completely tighten.
- ❑ Install and completely tighten the 1/2" NPT x 5/8" flare elbow into the tee with the flare facing up, opposite the union fitting, see photo J.

- ❑ Take the above assembly and feed over the pump motor so the flare elbow protrudes through hole in the side frame and assemble the union collar to hold the assembly in place on the motor. Completely tighten the union collar positioning the assembly as shown in photos I & J.
- ❑ Install a 1/2" x 5/8" flare elbow into the outlet of the VAC pump and tighten to face either the vapor tee mounted on the dispenser frame if available or the 1" vapor riser.
- ❑ Measure, cut, install flare nuts and flare a piece of 5/8" OD copper tube to fit between the flare fitting in the top vapor manifold and the flare elbow assembly just installed, see photo K.

## 9. INSTALLING THE SEALED NIPPLE ASSEMBLY:

- ❑ In the extreme left corner, "A" (J box) side of the vapor barrier there is a sealed knockout, (may be obscured by a plastic rain tray). Remove the bolt, nut and washer assembly to open the hole.
- ❑ Install the 1346 sealed nipple assembly by removing the first nut and washer, turn the other nut up fully on the threads and feed the wires down from the top of the vapor barrier to the hydraulics area, see photo L. Re-install the washer and nut over the wires and turn onto the first couple of threads leaving the nipple loose at this time.
- ❑ Get a 1/2" x 7" conduit nipple and install the female half of the electrical union on one end and a 3/4" x 1/2" reducer on the other end. To the reducer, attach the 3/4" electrical coupling. Install this assembly to the sealed nipple, see photo M. NOTE: Electrical fittings must be installed with a minimum of five threads.



**Photo L**

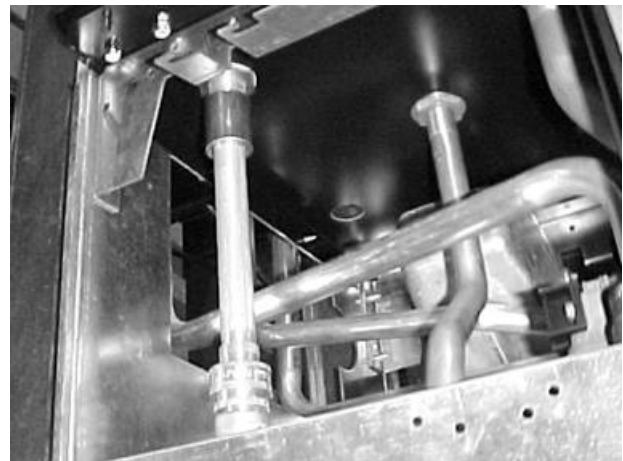

**Photo M**

- ❑ On the pump motor, install a 1/2" x 7" conduit nipple, a 1/2" electrical coupling and a 1/2" x 4-1/2" nipple, see photo N.
- ❑ Get the electrical "J" box, remove the cover and install a 3/4" x 1/2" reducer bushing into each hub. Install the "J" onto the 4-1/2" nipple positioned as shown in photo N.
- ❑ Install a 1/2" electrical close nipple to "J" box followed by the pull elbow, see photo O. Remove the pull elbow cover.



- ❑ Install the male half of the electrical union to the pull elbow. Run wires through the pull elbow and into the “J” box. Connect the union half’s together being careful not to pinch wires, reinstall the pull elbow cover and tighten the nut on the potted nipple.
- ❑ At the ‘J’ box, cut all the wires leaving at least 6” on each piece. Strip all wires about 1/2” and join the wires color for color, using wire nuts supplied. Coil all wires and place into box, replace the cover.



**Photo N**

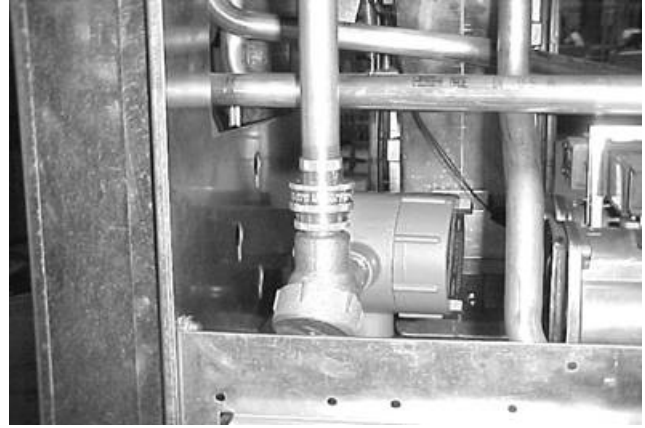

**Photo O**

## 10. WIRING THE ELECTRONICS

- ❑ Place the module loosely in the area for mounting, see photo P. Dress the harness wires from the module under the partition and up to the valves board in the center compartment, see photos P & Q.
- ❑ Connect the wires from the sealed nipple to the interface module as follows:
  - Black wire to ‘motor ‘ on module
  - White wire to ‘neutral’ on module
  - Red wire (either) to ‘output 1’ on module
  - Red wire (other) to ‘output 2’ on module
  - Orange wire to ‘fault common’ on module
  - Purple wire to ‘fault input’ on module
  - Green wire needs a #8 ring tong lug (provided) installed and connected to any chassis ground (frame)
- ❑ Locate the harness cable from the module and bring up to the valves board. Disconnect the existing valve wire connector in the board (J3 connector, labeled Solenoid Valves) and plug it into the harness male connector. Plug the original female connector into the male connector on the harness, see photo Q.
- ❑ Mount the module as shown in photo R, using the 8-32 x 3/4” screw and nut supplied in the electrical kit. There is an existing hole in the chassis that is the right size and in the right place for the screw.
- ❑ Locate the black and white twisted pair wire from the module with a connector and plug into any vacant receptacle on the power distribution board (CM301) located at the center of the front frame rail.

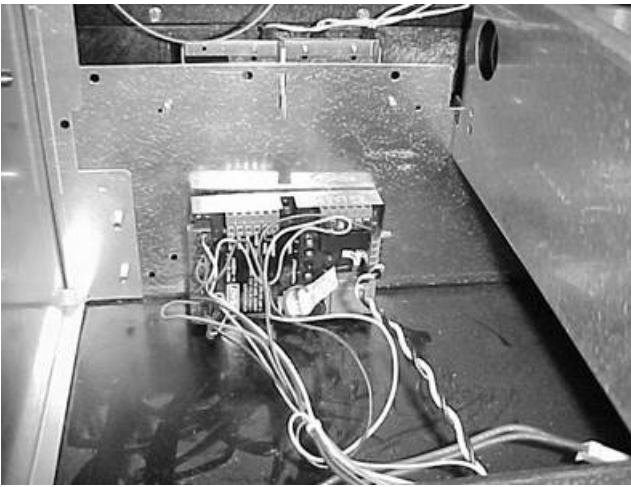

**Photo P**

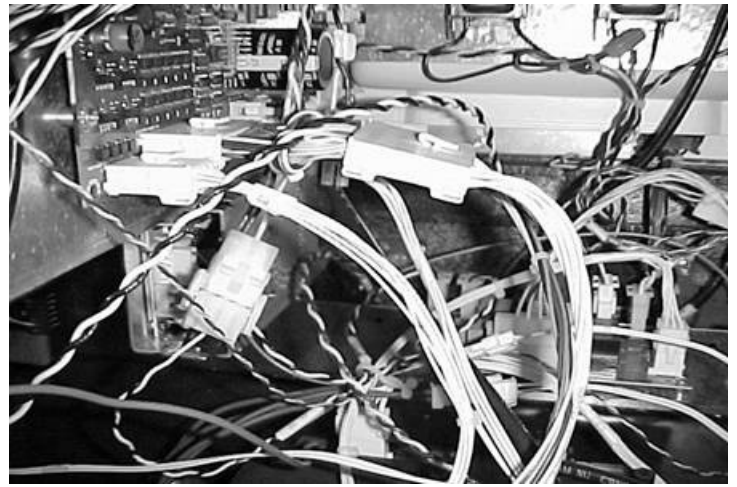

**Photo Q**

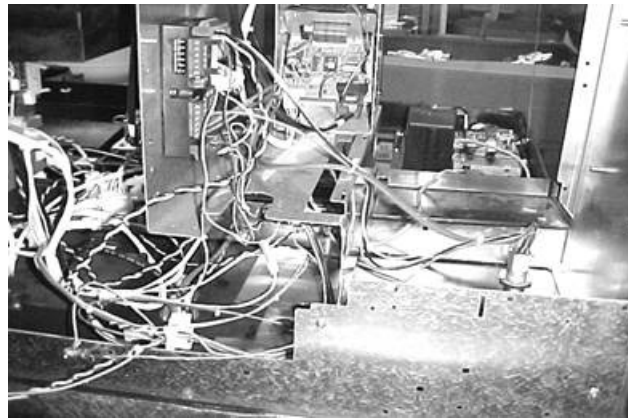

**Photo R**

Install the following labels supplied:

- NOTICE label for current increase (1405), install on the inside of the cabinet panel near the existing power consumption label, see photo S.
- Large NOTICE label (1406) relating to the vapor recovery upgrade and how to reset the electronic module should be installed near the module, where it will be readily visible to a service technician on the inside of the cabinet near the nozzle spout housing, see photo T.
- UL, retrofit kit identification number (1410), install near the electronic module.



Photo S

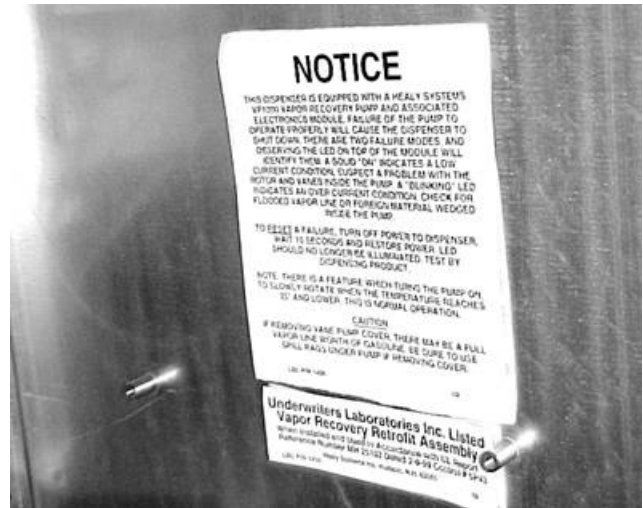

Photo T

## 11. CONNECTING HEALY SYSTEMS DISPENSING EQUIPMENT

- ❑ Completing the connection of Healy Systems dispensing equipment requires the installation of Healy Systems Phase II dispenser adaptors, hoses and nozzles (Hanging Hardware).
- ❑ If applicable, remove existing non-Healy hanging hardware (from the dispenser product outlet adaptor to and including the nozzles).
  - Vapor ready dispensers will require a Healy Systems adaptor to make the hose threads compatible with other Healy Systems equipment. Install following instructions packed with the adaptor. Various adaptors are available, depending on how the dispenser is configured: M34 metric (Healy designation F3 or S3) or balance ready (Healy designation S4).
  - Healy Vapor Recovery Hoses are available in various lengths to satisfy local ordinances and still provide “far side” fueling capability. Install these following instructions contained on the shipping box.
  - Breakaways are required: Install either Model 8701VV breakaway or Model 807 swivel breakaway; install using the instructions supplied with the unit.
  - The Healy Systems nozzle Model 900 (EVR) series is the only nozzle necessary to complete the upgrade. Check to be sure that the nozzle hanger is mounted in the highest position. Be sure to check for proper fit in the nozzle holster and that the nozzle can be locked in the off position. Also, be sure that when the nozzle is locked, that the dispenser cannot be activated from the locked position.

## 12. VP1000 THEORY OF OPERATION

The Healy Systems VP1000 is a self-contained rotary vane pump, designed for gasoline vapor recovery utilizing various parts of the Healy System Vapor Recovery product line. It is intended for use by either OEM dispenser/pump manufacturers or as an after market add-on to make existing equipment compatible with Healy System technology. In order to convert to 'others' equipment, an electronic interface is required to adapt the targeted pump/dispenser to the new vapor recovery equipment. The interface senses when authorization to dispense has been given and sends signals to the motor to operate at a low speed for one hose, or a higher speed for two hoses. It also functions to shut off the pump/dispenser if it senses that the vapor pump is not operating properly. The vacuum is regulated at a level sufficient to clear liquid gasoline from the vapor path in MPD applications. The actual amount of vapors withdrawn is controlled by the Healy nozzle, itself, in response to the liquid gasoline flow rate.

### MOTOR SPECIFICATIONS

Horsepower	1/8 HP
Voltage	120 VAC

### INTERFACE SPECIFICATIONS

Input voltage	120 VAC
Relay current capacity	5AAC
Input signals	AC and DC voltages up to 130 VAC max
Motor Input signal	5 VDC @ 20 Hz 50% Duty Cycle

### 13. TESTING THE SYSTEM:

- Carefully review all work completed, being sure all mechanical joints are thoroughly tightened and electrical connections sealed.
- Open the product crash valves and restore power to the dispenser.
- With the power on, but no nozzles authorized, the VP1000 should not be running (unless the ambient temperature is below 40°F), but the power LED (yellow) should be energized on the interface module.
- Authorize one handle and the vacuum system should activate when the gasoline flow control valve is engaged. Repeat for all other nozzles, individually testing each nozzle on each side of dispenser. With each authorization, one of the green LED's on the interface module should illuminate and the VP1000 activate.
- Note: For unihose dispensers, conduct individual tests for each product grade on each side of the dispenser to ensure that the same LED activates for all grades on the same side. If the other LED activates, wiring needs to be corrected.
- Authorize one nozzle and listen to the speed of the VP1000. With only one nozzle activated, the speed will be slower than if a nozzle on each side is activated. Activate a nozzle on the other side of the dispenser and listen for the speed to change.
- To test the tightness of the vapor plumbing installed on the suction side of the system requires a 0-100" water column gauge. Connect the gauge into the 1/4" test port of the reducing tee installed earlier in section 8, photo I. Continue by following and completing the START-UP / NEW INSTALLATION / WARRANTY / ANNUAL TESTING FORM.

### 14. TROUBLESHOOTING THE VP1000:

- Use extreme care and caution when performing the tests listed below. If 120 VAC is accidentally applied to the fault or DC terminals, the module will be destroyed.
- With power applied to the dispenser, but no products authorized, there should be 120 VAC between neutral and 120 VAC on the module terminal strip.
- As above, with any product authorized, there should be single speed power applied to the VP1000. Verify this by checking for 2-3 VDC from OUTPUT 1 (RED WIRE) to FAULT COMMON (ORANGE WIRE), (or from OUTPUT 2 TO FAULT COMMON) also; one GREEN LED should be illuminated. With a second product authorized on the opposite side of the dispenser i.e. one product on each side, the motor should operate at higher speed and there should be 2-3 VDC on both output 1 and 2 (to fault common) and both GREEN LED's should be illuminated.
- With the pump running, a fault can be simulated by shorting, with a jumper wire, the "FAULT INPUT" (purple wire) to FAULT COMMON (orange). This should cause the motor to shut off, the solenoid valves to lose power and the dispenser to shut down. Also, as long as the short is maintained, the red LED will be illuminated. Removing the short will not automatically reset the module. To reset the module, remove the short, remove power to the dispenser for twenty seconds and restore power. The module should now be reset and the red led extinguished. This can also be accomplished by using the power reset (PWR RESET) on the module.

- If diagnosing a problem where the LED is already illuminated, a steady light indicates a low current condition, therefore expect a vane or rotor problem. If the LED is blinking, that indicates a high current condition and would expect to find a jammed rotor or vapor line flooded with product. See Start-up / New Installation / Warranty / Annual Testing Form.
- The electronics of the motor will make three attempts to have a successful start of the motor. If it detects a problem, on the fourth unsuccessful start, it will short the fault line to signal minus (DC-) and shut down the electronics.

### MC100 Interface Module

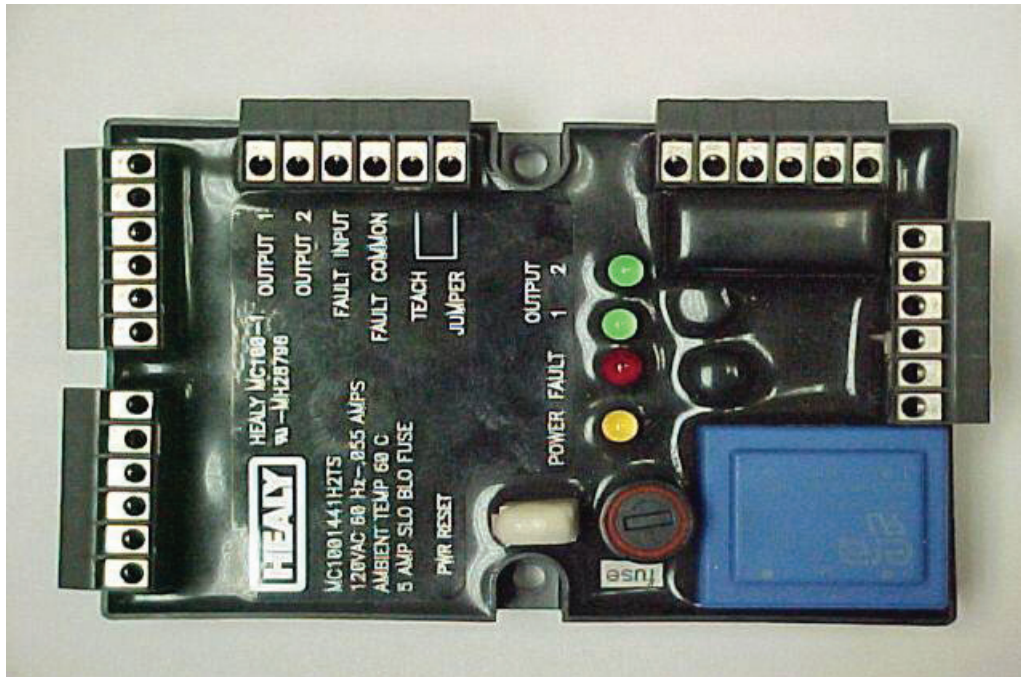

## 15. VP1000 VANE & ROTOR SERVICE & REPLACEMENT GUIDE

**Caution**  **Disconnect power before beginning service.**

1. The work area **must** be clean and have sufficient lighting.
2. Disconnect the vapor piping connected to the **IN** and **OUT** ports of the VP1000 cover assembly.
3. Remove the four Allen head screws and lock washers that secure the pump cover assembly to the pump housing and remove the cover carefully.

**Caution**  **Use a spill cloth when removing the cover, as there may be some gasoline inside the pump cavity.**

4. Carefully turn the rotor assembly by hand until the shaft key notch is at the 12 o'clock position. (See Figures)
5. Remove the rotor, vanes and shaft key from the pump housing.

**Note:** Place your hand or a container under the rotor while removing. Do not use any sharp objects that would scratch the surfaces of the pump cavity, pump shaft, rotor, or vanes.

6. Rotate the shaft by hand. If the shaft does not rotate freely, the entire vacuum pump needs replacement (p/n VP1000-5 or RVP1000-5).
7. If the rotor and vanes are cracked, chipped, excessively worn or excessively dirty, the rotor and vanes should be replaced because cleaning will not remedy these conditions (p/n VP1000VRC-G, VP1000VRC-P or VP1000VRC).
8. If there is no visible damage, use a lint-free cloth with isopropyl alcohol to clean the rotor and vanes.
9. Using a lint-free cloth with isopropyl alcohol, thoroughly clean: the inside of the pump ring and rear of the pump cavity, the rotor shaft, and the inside of the pump cover.
10. Reposition the shaft (if necessary) so that the shaft key notch is in the 12 o'clock position. Install the cleaned original or new shaft key onto the shaft.
11. Carefully install the cleaned original or new rotor onto the shaft followed by the cleaned original or new vanes into the rotor.

**Note:** The rotor assembly should slide on to the shaft easily, without excessive force. (Rotors and vanes are reversible)

12. Lightly lubricate and install the new O-Ring for the pump housing.

**Note:** Do not allow any lubricant to get inside the pump housing.

13. Install the pump cover using the four Allen head screws and lock washers removed in step 3 and cross tighten.

**Note:** Use caution when sliding the pump cover over the O-Ring seal to prevent cutting or tearing.

14. Re-connect the vapor piping to the **IN** and **OUT** ports of the pump cover assembly that was removed in Step 2.
15. Re-apply power. Test for normal operation. (See VP1000 Vacuum Performance Test Procedure)

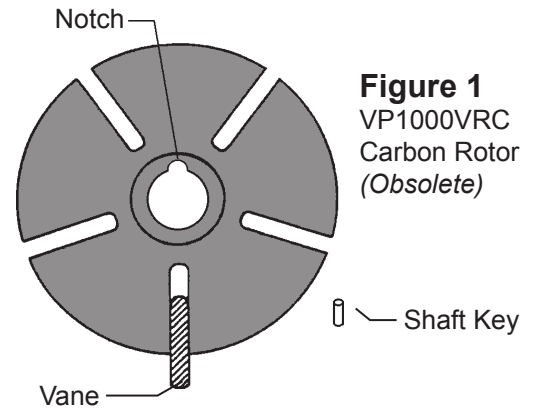

**Figure 1**  
VP1000VRC  
Carbon Rotor  
(Obsolete)

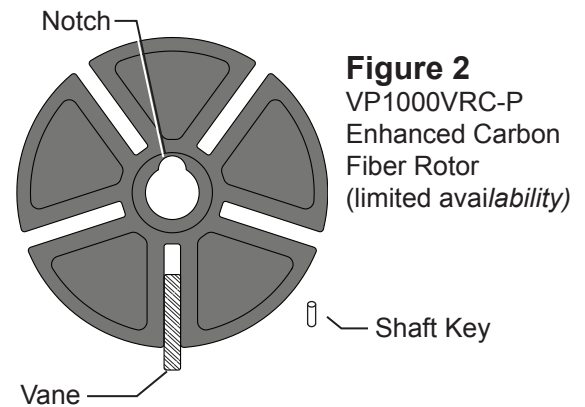

**Figure 2**  
VP1000VRC-P  
Enhanced Carbon  
Fiber Rotor  
(limited availability)

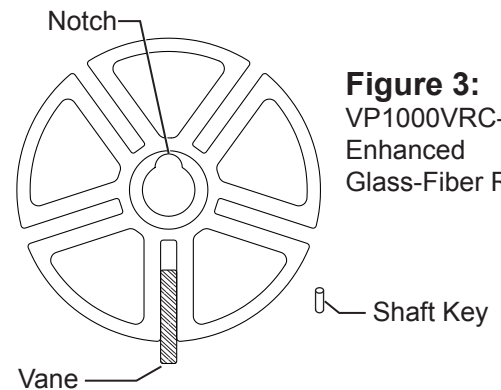

**Figure 3:**  
VP1000VRC-G  
Enhanced  
Glass-Fiber Rotor

START-UP/NEW INSTALLATION/ WARRANTY/ ANNUAL TESTING FORM (Rev. 10/07)  
HEALY VP1000 VACUUM PUMP

Date \_\_\_\_\_

**BOTH SIDES OF THIS TEST FORM MUST BE COMPLETED FOR NEW INSTALLATIONS**

- **Start-up / New installations** – complete **SIDE A** and sections 3, 4, 5 and 6 of **SIDE B**. Submit forms to Healy Systems.
- **Warranty Service or Annual Testing** – complete contact information, dispenser make, vacuum pump serial # and the tests in sections 1 and 2 on **SIDE A** and conduct the appropriate tests specified on **SIDE B**. Submit Forms to Healy Systems.

SERVICE COMPANY NAME	TELEPHONE	
SERVICE TECHNICIAN	HEALY TECH CERT #	
STATION ADDRESS	CITY	STATE
DISPENSER MAKE	VACUUM PUMP SERIAL #	

## SIDE A

DISPENSER EQUIPMENT CHECKLIST - Parts A-1 and A-2	YES	NO*
<b>A-1</b> Is all the installed dispenser hanging hardware listed in Exhibit 1 of Executive Order VR-201 or VR-202?	<input type="checkbox"/>	<input type="checkbox"/>
<b>A-2</b> Proper installation of the VP1000 requires the test port and ball valve on the inlet side of the vacuum pump. Are the test port and ball valve installed correctly?	<input type="checkbox"/>	<input type="checkbox"/>
<b>*If the answer to either A-1 or A-2 is NO, the Healy Warranty is Void.</b>		

### A-3

- THE FOLLOWING TEST WILL PERFORM A POSITIVE PRESSURE LEAK CHECK OF THE VACUUM PUMP, DISPENSER VAPOR PIPING, HANGING HARDWARE AND ALL NOZZLES ON BOTH SIDES OF THE DISPENSER.
- THE VP1000 OUTLET IS NOT CONNECTED TO UNDERGROUND PIPING DURING THIS TEST.

**CAUTION: REGULATE GASEOUS NITROGEN TO 2.5 PSI (~70" WC) MAXIMUM BEFORE TESTING**

1. Install a 0-100 inch water column (" wc) mechanical gauge at the VP1000 test port.
2. Use the water column gage positive (high) pressure port.
3. Gaseous nitrogen gas can now be connected to the outlet (exhaust) port of the VP1000.
4. Test pressure **cannot** exceed 70" wc.
5. **Slowly** introduce the gaseous nitrogen to a pressure between 60 – 70" wc.
6. After reaching the pressure range, close the valve supplying the gaseous nitrogen.
7. Record the initial pressure reading on the gauge - observe and record the final pressure reading after 60 seconds.
8. Leaks must be repaired when the pressure falls more than 4" wc in 60 seconds.
9. Retest until all leaks have been repaired.
10. Record test results in Section A-4.

<b>A-4</b> <b>PRESSURE TEST</b> 2.5 PSI (~70"wc) Maximum	Initial Pressure test reading ("wc)	Pressure test reading after 60 seconds ("wc)
--	-------------------------------------	--



START-UP/NEW INSTALLATION/ WARRANTY/ ANNUAL TESTING FORM (Rev. 10/07)  
HEALY VP1000 VACUUM PUMP

Date \_\_\_\_\_

**BOTH SIDES OF THIS TEST FORM MUST BE COMPLETED FOR NEW INSTALLATIONS**

- **Start-up / New installations – complete SIDE A and sections 3, 4, 5 and 6 of SIDE B. Submit forms to Healy Systems.**
- **Warranty Service or Annual Testing – complete contact information, dispenser make, vacuum pump serial # and the tests in sections 1 and 2 on SIDE A and conduct the appropriate tests specified on SIDE B. Submit Forms to Healy Systems.**

<b>SIDE B</b>					
	<i>Warranty Service</i> Complete Troubleshooting Sections <b>B-1 and B-2</b>	<i>Start-up/ New Installations/ Annual Testing</i> Complete Sections <b>B-3 through B-6</b>			
<b>B-1</b>	<p style="text-align: center;"><b>Control Module Fault Light</b> (Circle one)                      <b>Flashing (LED)</b>                      <b>Steady (LED)</b></p> <p>1. All fault conditions require removal and cleaning or replacement of the rotor and vanes located inside the vacuum pumps round front cover assembly. Use the <b>VP1000 ROTOR &amp; VANE SERVICE AND REPLACEMENT GUIDE</b> in the applicable dispenser retrofit manual of the ARB Approved Installation, Operation and Maintenance Manual for Executive Orders VR-201-O and VR-202-O.</p> <p>2. Clean all surfaces including vanes, rotor, rotor housing and cover assembly.</p> <p>3. Manually spin and inspect the motor shaft for bearing wear before re-installing the rotor kit.</p> <p>4. Replace motor when bearings or shaft are damaged or worn.</p> <p>5. Check O-ring seal before replacing rotor cover assembly.</p>				
<b>B-2</b>	<p>Re-Assemble / Reset Vacuum Pump and Module. (Power must be removed from both the vacuum pump and the <b>module for 20 seconds to reset the system</b>) using the power reset switch on the MC100 module.</p>				
<b>B-3</b>  Dispenser Vapor Line Integrity Test	<p>1. Install 0-100 inch water column (“ wc) vacuum mechanical gauge at the VP1000 test port.</p> <p>2. Authorize the dispenser for fueling. The VP1000 will begin to run.</p> <p>3. Close the ball valve at the pump inlet.</p> <p>4. Record the initial vacuum reading on the gauge – observe and record the final vacuum reading after 60 seconds.</p> <p>5. Open the ball valve at the pump inlet.</p> <p>6. Leaks must be repaired when the vacuum reading falls more than 4” wc in 60 seconds.</p> <p>7. Retest until all leaks have been repaired.</p> <p>8. Record data in Section B-4.</p> <p><b>Note: If the initial vacuum reading is less than 60” wc, it could indicate a problem with the VP1000. Remove the dispenser from service. Use the troubleshooting section of the manual to investigate problem or contact the FFS Technical Help Desk at 800-984-6266 for assistance.</b></p>				
<b>B-4</b>	VACUUM TEST Using VP1000 as vacuum source	<table style="width: 100%; border: none;"> <tr> <td style="border: none; width: 30%;"></td> <td style="border: none; width: 30%; text-align: center;">Initial Vacuum test reading (“ wc)</td> <td style="border: none; width: 30%; text-align: center;">Vacuum test reading after 60 sec. (“ wc)</td> </tr> </table>		Initial Vacuum test reading (“ wc)	Vacuum test reading after 60 sec. (“ wc)
	Initial Vacuum test reading (“ wc)	Vacuum test reading after 60 sec. (“ wc)			
<b>B-5</b>  Dispenser Vacuum Test	<p>With one side of the dispenser authorized (VP1000 running) and the ball valve at the pump inlet open, dispense in handheld position a minimum of 0.5 gallons of fuel into a vehicle or test tank. Record the vacuum level while dispensing. Repeat test for the other side of the dispenser.</p> <p>1. Side “A” Dispensing Vacuum _____” wc</p> <p>2. Side “B” Dispensing Vacuum _____” wc</p> <p><b>Note: If the dispensing vacuum is less than 60” wc, remove the dispenser from service. See the troubleshooting section of the manual or contact FFS Technical Help Desk at 800-984-6266 for assistance.</b></p>				
<b>B-6</b>  Audible Increase Test	<p>Test the VP1000 Vacuum Pump for normal operation. Use the 6 step procedure titled, “Testing the VP1000 Vacuum Pump for normal operation using the following test procedure:” in Section 1.1 (Weekly Inspection and Testing) of the Healy Systems Scheduled Maintenance document in the ARB Approved Installation, Operation and Maintenance Manual for the Healy Phase II EVR System not including ISD. This is to verify that the pump recognizes when both sides of the dispenser are activated for fueling.</p> <p>Does the VP1000 Vacuum Pump change speeds (audible increase) when both sides are activated for fueling?</p> <p style="text-align: center;">Yes    No</p> <p>If the answer is no, <b>use the troubleshooting section of the manual to investigate problem or contact the FFS Technical Help Desk at 800-984-6266 for assistance.</b></p>				
Repairs - Comments	To Obtain Returned Materials Authorization number (RMA#) Call 800-984-6266 Forms can be faxed to Franklin Fueling Systems Customer Service at 800-225-9787				

Franklin Fueling Systems  
3760 Marsh Road  
Madison, Wisconsin 53718 USA  
ARB Approved Installation, Operation and Maintenance Manual

Website: <http://www.franklinfueling.com>  
Email: [sales@franklinfueling.com](mailto:sales@franklinfueling.com)  
Telephone: 800-225-9787  
Fax: 608-838-6433

