



# Vapor Recovery Monitoring

---

Installation, Operation, and Maintenance Manual  
For use with Healy Vapor Recovery System  
*Software Version 1.2.0*

---

**Franklin Fueling Systems** • 3760 Marsh Rd. • Madison, WI 53718 USA  
Tel: +1 608 838 8786 • 800 225 9787 • Fax: +1 608 838 6433 • [www.franklinfueling.com](http://www.franklinfueling.com)

## **Notice**

Franklin Fueling Systems (FFS) reserves the right to change this document and specifications at any time without notice. FFS makes no expressed or implied warranty with regard to the contents of this manual. FFS assumes no liability for errors or omissions, or for any damages, direct or consequential, that may result from the use of this document or the equipment that it describes. No part of this document may be reproduced in any form without the prior written consent of FFS.

## **Trademarks**

INCON, Fuel Management System, System Sentinel, SCALD, Brite, BriteBox, BriteBus, and BriteSensors are registered trademarks of Intelligent Controls. All brand and product names are trademarks or registered trademarks of their respective companies.

## **Inspection of Materials**

Visually inspect all components for defects or damage prior to installation. If any defects or damage is found, do not use the product and contact FFS for further assistance.

## **Return Shipping Charges**

FFS will not accept shipments of returned products without a Return Goods Authorization (RGA) number. RGAs are obtained by contacting FFS's Technical Service Division — NO RGAs will be given without the unit's serial number(s). Returned goods remain the property of the buyer until replaced or repaired.

## **Contacting Franklin Fueling Systems (FFS)**

Please feel free to contact us by mail at:

Franklin Fueling Systems  
3760 Marsh Rd.  
Madison, WI 53718 USA

Or contact us by phone, fax, or email:

**Tel:** 1 608 838 8786

**Fax:** 1 608 838 6433

**Tel:** US & Canada 1 800 225 9787

**Tel:** México 001 800 738 7610

**Tel:** Europa +49 6571 105 380

**E-mail:** [sales@franklinfueling.com](mailto:sales@franklinfueling.com)

[techserve@franklinfueling.com](mailto:techserve@franklinfueling.com)

**Office Hours:** 8am to 5pm CST - Monday through Friday

Please visit our Web site at [www.franklinfueling.com](http://www.franklinfueling.com)

# Contents

<b>Notice</b> .....	2
Trademarks .....	2
Inspection of Materials.....	2
Return Shipping Charges.....	2
Contacting Franklin Fueling Systems (FFS) .....	2
<b>Important Safety Messages</b> .....	4
<b>Introduction</b> .....	5
Certified Contractor Requirements .....	5
Definitions and Acronyms .....	5
Related Documents .....	5
<b>Product Description</b> .....	6
Vapor Recovery Monitoring.....	6
VRM System Specification .....	8
<b>Installation &amp; Startup</b> .....	9
TS-550/5000/EMS Console Installation.....	9
TS-VFM Installation .....	9
TS-VPS Installation.....	9
Dispenser Hook Signals.....	10
Dispenser Power Control .....	10
Dispenser Interface Module.....	11
Ullage Volume Input.....	11
<b>Setup and Programming</b> .....	12
Startup .....	12
System Status.....	12
Programming the Console for Vapor Recovery Monitoring.....	13
Data Transfer Units .....	13
Dispenser Hooks Mapping.....	13
Vapor Flow Meter Select.....	13
Vapor Pressure Sensor Select.....	13
Remote ATG Serial Port Settings.....	13
Relay Mapping .....	14
Dispenser Interface .....	14
Vapor Recovery Monitoring Setup .....	15
Managing Rules.....	16
Setting Up Email Notification .....	17
<b>System Operation</b> .....	18
Run-Time Status .....	18
Vapor Recovery Web Pages.....	18
<b>Alarms, Warnings, and Failures</b> .....	22
System Alarms .....	22
Vapor Recovery Alarms .....	22
<b>Reports &amp; Printing</b> .....	25
Creating Reports .....	25
Printing Reports .....	26
Printing VRM Report examples .....	27
<b>Maintenance</b> .....	28
General Inspection.....	28
<b>Diagnostics</b> .....	29
Pressure and Transaction Log Files .....	29
Pressure Log Files.....	29
Transaction Log files.....	30
Steps to Download Log Files .....	31
<b>INCON VRM Startup Checklist</b> .....	32
<b>Appendix A: Alarm Codes</b> .....	33

## Important Safety Messages

INCON equipment is designed to be installed in association with volatile hydrocarbon liquids such as gasoline and diesel fuel. Installing or working on this equipment means working in an environment in which these highly flammable liquids may be present. Working in such a hazardous environment presents a risk of severe injury or death if these instructions and standard industry practices are not followed. Read and follow all instructions thoroughly before installing or working on this, or any other related, equipment.

As you read this guide, please be aware of the following symbols and their meanings:

**Warning**  This symbol identifies a warning. A warning sign will appear in the text of this document when a potentially hazardous situation may arise if the instructions that follow are not adhered to closely. A potentially hazardous situation may involve the possibility of severe bodily harm or even death.

**Caution**  This is a caution symbol. A caution sign will appear in the text of this document when a potentially hazardous environmental situation may arise if the instructions that follow are not adhered to closely. A potentially hazardous environmental situation may involve the leakage of fuel from equipment that could severely harm the environment.

**Danger**  This symbol identifies an electrical danger. An electrical danger sign will appear in the text of this document when a potentially hazardous situation involving large amounts of electricity may arise if the instructions that follow are not adhered to closely. A potentially hazardous situation may involve the possibility of electrocution, severe bodily harm, or even death.

---

**Warning**  **Follow all applicable codes governing the installation and servicing of this product and the entire system. Always lock out and tag electrical circuit breakers while installing or servicing this equipment and any related equipment. A potentially lethal electrical shock hazard and the possibility of an explosion or fire from a spark can result if the electrical circuit breakers are accidentally turned on during installation or servicing. Please refer to the *Installation and Owner's Manual* for this equipment, and the appropriate documentation for any other related equipment, for complete installation and safety information.**

**Warning**  **Follow all federal, state and local laws governing the installation of this product and its associated systems. When no other regulations apply, follow NFPA codes 30, 30A and 70 from the National Fire Protection Association. Failure to follow these codes could result in severe injury, death, serious property damage and/or environmental contamination.**

**Warning**  **Always secure the work area from moving vehicles. The equipment in this manual is usually mounted underground, so reduced visibility puts service personnel working on this equipment in danger from moving vehicles entering the work area. To help eliminate these unsafe conditions, secure the area by using a service truck to block access to the work environment, or by using any other reasonable means available to ensure the safety of service personnel.**

**Warning**  **When the console system is used to monitor tanks containing gasoline or other flammable substances, you may create an explosion hazard if you do not follow the requirements in this manual carefully.**

**Warning**  **All wiring must enter the console's enclosure through the designated knockouts. An explosion hazard may result if other openings are used.**

**Warning**  **All wiring from probes or sensors to the console must be run in conduit separate from all other wiring. Failure to do so will create an explosion hazard.**

**Warning**  **Substituting components could impair intrinsic safety. T5 series consoles are intrinsically safe for sensors installed in – Class I, Division 1, Group D – hazardous locations. Substitution of components could make the energy limiting circuitry in the system ineffective and could cause an explosion hazard. Repairs to a T5 series console or attached components should only be performed by a qualified, factory-trained technician.**

## **Introduction**

The purpose of this manual is to guide installers, operators, and store owners with setting up their INCON Vapor Recovery Monitoring (VRM) system. The VRM system has been tested and approved by the California Air Resource Board as an In-Station Diagnostics (ISD) system per CP-201. This manual introduces the user interface then proceeds to setup and lastly, maintaining your VRM system.

For installation of the TS-550, TS-5000, TS-EMS and its components please refer to the *TS-5xxx Series Installation Guide* (p/n 000-2150).

## **Certified Contractor Requirements**

Please read this entire manual carefully. Failure to follow the instructions in this manual may result in faulty operation, equipment damage, injury or death.

### **Contractor Certification Levels**

- LEVEL I - Automatic Tank Gauge Installer Certification Training
- LEVEL II - Automatic Tank Monitor Start-Up and Service/Warranty Certification Training
- LEVEL III - LLD Installer/Service/Warranty Certification Training
- LEVEL IV - TS-STC Operation/Repair Test
- LEVEL V - Vapor Recovery Monitoring Installation/Operation

**Certified Programmer/Service Person:** Only an INCON certified VRM Technician or service person is allowed to make setup changes, clear alarms, and access areas internal to the Console. A certified contractor needs to have completed training levels I, II, and V.

**Station Owner/Operator:** The station owner or operator of the console is only allowed to print reports and re-enable dispensers. Making setup changes, clearing alarms, and accessing areas internal to the console is strictly prohibited.

## **Definitions and Acronyms**

**A/L** – Air over Liquid ratio, this ratio is calculated at the end of the day for each fueling point.

**ATG** – Automatic Tank Gauge

**CARB** – California Air Resources Board

**DTU** - Data Transfer Unit. Device used to transmit VFM and VPS data over existing power lines

**EVR** – Enhanced Vapor Recovery

**GDF** – Gasoline Dispensing Facility

**ISD** – In-Station Diagnostics. This refers to the whole system as defined in CP-201.

**ISP** – Internet Service Provider

**LLD** – Line Leak Detector

**Modules** – These are the different plug-in cards within the T5 series console enclosure. They are the inputs and outputs for all the field wiring.

**Console** – The console is the physical box installed on the wall. The system console holds the entire electronic slide in modules and runs the general operating system. The VRM application is available in the TS-550/EMS/5000 models of the console.

**PLC** - Power Line Communication. This refers to the technology of transferring digital data over AC power lines

**TS-VFM** – Vapor Flow Meter

**TS-VPS** – Vapor Pressure Sensor

**TSA** – Tank Sentinel Anyware is the web-based interface to the console.

**VRM** – Vapor Recovery Monitoring is the application that runs on the console and performs In-Station Diagnostics.

## **Related Documents**

000-2144, *TS-VFM Installation Guide*

000-2143, *TS-VPS Installation Guide*

000-2150, *TS-5xxx Installation Guide for TS-5, TS-550, TS-5000, and TS-EMS*

000-2142, *TS-5xxx Programmer's Guide for TS-5, TS-550, TS-500, and TS-EMS*

000-2151, *TS-5xxx Operator's Guide*

CP-201, *Certification Procedure for Vapor Recovery Systems at Gasoline Dispensing Facilities*

TP-201.3, *Determination of a 2" Static Pressure Performance of Vapor Recovery Systems of Dispensing Facilities*

TP-201.5, *Air to Liquid Volume Ratio*

## Product Description

### Vapor Recovery Monitoring

The Vapor Recovery Monitoring System (VRM) consists of the following components.

#### Vapor Recovery Monitoring Application

The Vapor Recovery application uses data from the Vapor Flow Meters (VFM) and the Vapor Pressure Sensor (VPS) to perform assessments on the site's vapor recovery system. VRM is an optional application on the console and may be accompanied by Fuel Management System or Secondary Containment Monitoring.

#### Console

The Console consist of either the TS-550 or TS-5000 Fuel Management Systems or the TS-EMS, Environmental Monitoring System. The console options for ISD monitoring will always include the VRM application and at least one of each of the following components. (See Figure 1)

- AC Input Module
- Relay/10A Relay Module
- Probe Module
- 4-20mA Module
- Dispenser Interface Module
- Printer
- Touchscreen



#### Vapor Flow Meter

The Vapor Flow Meter (TS-VFM) is a volume measuring meter. When a mixture of air and gasoline vapors are returned from an automobile's gasoline tank to the underground storage tank during a dispense, the vapors are measured and analyzed. The console uses these VFMs as a way to assess how well the vapor collection process is working. The VFM is used to perform the following CP-201 assessments.

Assessment Type	Duration	EVR System	Threshold
Daily A/L	Daily	Vacuum Assist	Average A/L ratio exceeds 1.90 or less than 0.33
Weekly A/L	Calendar Week	Vacuum Assist	Average A/L ratio exceeds 1.32 or less than 0.81

There shall be one VFM per dispenser, and they wire into the Probe Module. Refer to document *Vapor Flow Meter Install Guide* (p/n 000-2144) for installation methods.

#### Vapor Pressure Sensor

The Vapor Pressure Sensor (TS-VPS) is a low vapor pressure transmitter. The primary purpose of the VPS is to continually measure the underground storage tank's vapor containment pressure. This vapor containment area includes the tank ullage area, and the vapor piping. The VRM continually samples the VPS and performs assessments for Over Pressurization and leakage in the vapor containment area. These assessments include:

Assessment Type	Duration	Threshold
Weekly Over-pressurization	Calendar Week	Pressure > 1.3" wcg for 5% of week
Monthly Over-Pressurization	Calendar Month	Pressure > 0.3" wcg for 25% of month
Weekly Leak Test	Calendar Week	Pressure Leak is greater than 2x TP-201.3

There is only one VPS per ISD installation. The VPS connects to the 4-20mA Module, refer to the *Vapor Pressure Sensor Install Guide* (p/n 000-2143). The pressure sensor shall be installed in the dispenser closest to the underground storage tanks.

## **AC Input Module**

In VRM Version 1.2.0, the use of dispenser AC Hook signals is not required. The AC Input Module may be used to monitor the dispenser hook signals. Dispenser hooks are the signals from the dispensers that are normally used to activate the submersible pumps. For the VRM application they are also used to signal the start and end of a transaction for gasoline products only. Vapor Recovery does not apply to Diesel and Kerosene products so the hook signals for these grades do not need to be monitored. Dispenser Hook Signals are to be wired to the AC-Input Module and the installation directions are in the *TS-5xxx Installation Guide* (p/n 000-2150).

## **Dispenser Interface Module**

The Dispenser Interface Module (TS-DIM) is used to acquire the volume of gasoline that was pumped during each transaction. Refer to the *TS-5xxx Installation Guide* (p/n 000-2150) for wiring the TS-DIM.

## **Ullage Volume**

The VRM System uses ullage volume for performing vapor containment leak detection. The console gathers ullage volume from internal inventory probes or an external ATG. When using an existing ATG for collecting ullage, then the ATG must have an available RS-232 port and have the ability to respond to TLS-250 or TLS-350 inventory command.

## **Relay/10A Relay Module**

Power to the dispensers will be controlled by the console in the event of a VRM Failure alarm. The dispenser power is to be controlled by the Relay Module per the installation directions in the *TS-5xxx Installation Guide* (p/n 000-2150). Electrical current through the Relay Module is not to exceed the maximum rated current listed on the module. If options in the dispensers will cause the current to exceed the rated current, including startup current, an external power relay will need to be used and its coil controlled by the Relay Model. See the *TS-5xxx Installation Guide* (p/n 000-2150) for installation instructions for the Relay Module and 10A Relay Module.

## **DTU Module**

The DTU Module is an optional device used to transmit the signals of the VPS and VFM to the console. The DTU will provide the ability to communicate over existing dispenser power lines thus eliminating the need to install field cable. For installation instructions of the DTU, refer to the TS-DTU Dispenser Retrofit Manual (pn 000-2146) and the Console DTU Installation Instructions (pn 000-0080).

## **Alarms**

The user will be automatically notified of VRM or other system alarm conditions via the alarm LEDs and touchscreen display. An audible alarm will sound and the system can also be setup to print or E-mail alarms (Ethernet connection required). Dispenser power is controlled by the console and cannot be disabled.

# VRM System Specification

Refer to the Executive Order 202, Exhibit 2, for the most up to date system specifications. The required equipment to be installed for the INCON VRM system is discussed below. Figure 1 shows the different components and where they attach to the Console. All items in bold are items directly related to the VRM application.

Figure 1

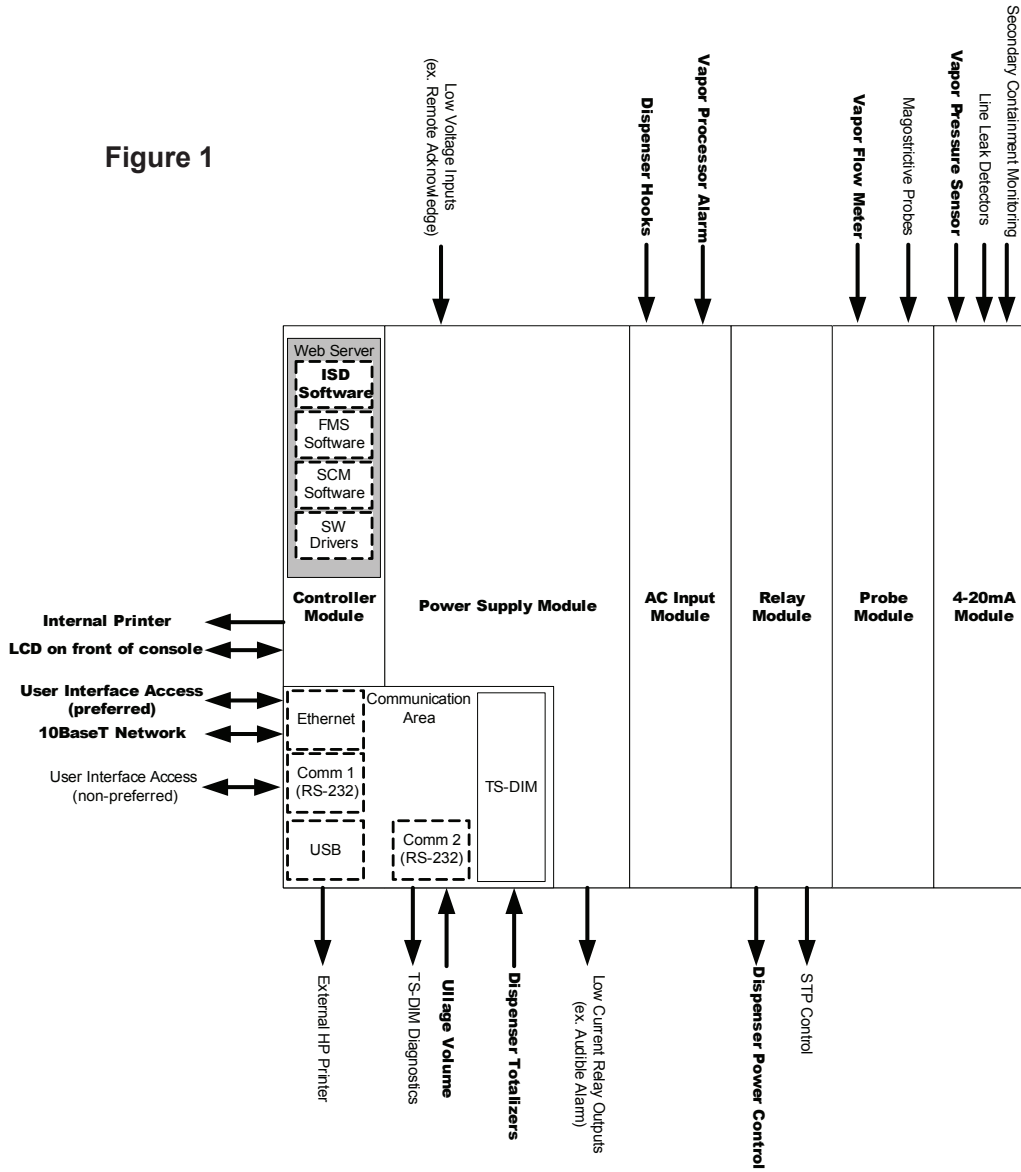



# Installation & Startup

## TS-550/5000/EMS Console Installation

The console will be shipped with all modules installed and tested. Refer to the *TS-5xxx Installation Guide* (p/n 000-2150) for mounting and wiring instructions.

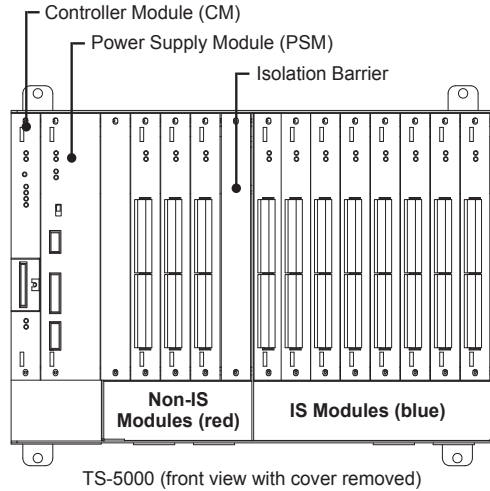

## TS-VFM Installation

### Field Installation

To mount the Vapor Flow Meter (VFM) in the dispenser and make the field wiring connections, follow the instructions in the *TS-VFM Install Guide* (p/n 000-2144).

### Console Wiring Connection

See Probe Module diagram at right. The VFM is wired to the Probe Module inside the Console. Wire the Red wire to the + terminal and the Black wire to the - terminal.

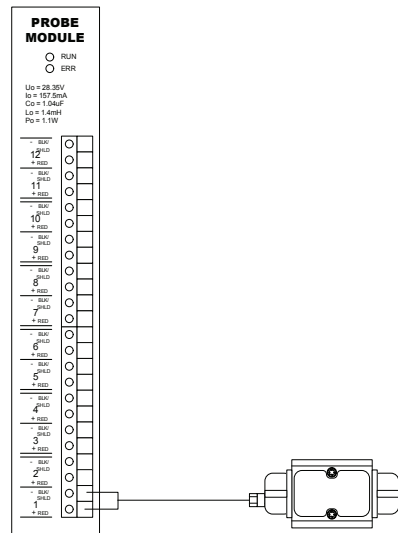

## TS-VPS Installation

### Field Installation

To mount the Vapor Pressure Sensor (VPS) and make the field wiring connections, follow the instructions in the *TS-VPS Install Guide* (p/n 000-2143). There will be only one pressure sensor per ISD System.

### Console Wiring

See diagram at right. The VPS is wired to the 4-20ma Module inside the Console. Wire the sensor's Black wire to the + terminal and the sensor's White wire to the - terminal.

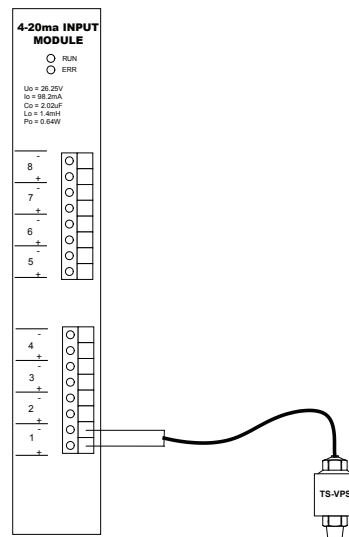

There are several different wiring schemes that may be encountered when connecting the AC Input Module and Relay Module. These are dependent upon the use of optional features like Dispenser Hook Isolation, Line Leak Detection (LLD) and Turbine Pump Interface that can affect the way these modules are wired. The description below assumes that this is strictly a VRM system that is sensing the dispenser hook signals from gasoline products only and not controlling the Submersible Turbine Pumps. For more information on the different wiring options see the *TS-5xxx Installation Guide* (p/n 000-2150) or contact Franklin Fueling Systems Technical Support at 1-800-984-6266.

## Dispenser Hook Signals

**Note:** Dispenser hook signals are required on installations prior to VRM versions 1.2.0.

The dispenser hook signals are sampled by the AC Input Module so that the VRM can monitor the start and end of gasoline sales transactions. Follow the instructions below to tap into the Dispenser Hook Signals with a parallel wire to the AC Input Module. This method will not take control of the Submersible Pumps.

1. Locate the gasoline product only dispenser hook signals at a point where they are still separated by dispenser. This may be a dispenser hook isolation box or other method or they may just all be connected with a wire nut.
2. Separate them by dispenser number then by fueling grade.
3. Connect a wire in parallel from the line and neutral of each dispenser hook signal to the AC Input Module. All existing wiring should remain as is.
4. When wiring the Dispenser Hook signals to the AC Input Module, make dispenser 1 signals (all gasoline grades) go to the first set of terminals. For example, if there are two hooks per dispenser (Regular and Super) then wire Dispenser 1 to positions 1 & 2, then Dispenser 2 to positions 3 & 4.

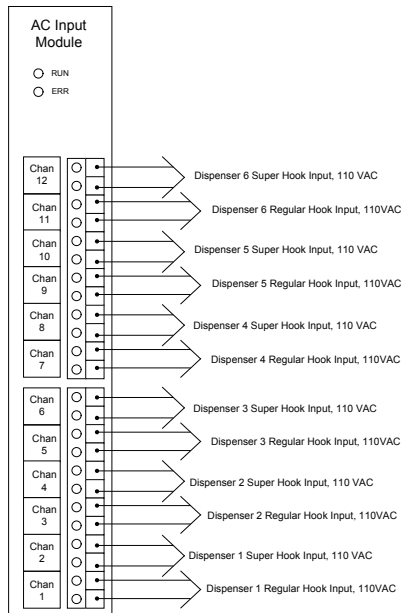

## Dispenser Power Control

In order for the console to shutdown a dispenser or all the dispensers in response to an alarm condition, the dispenser power must be controlled by the Relay Module. Run the coil of the dispenser power relay through the a channel of the Relay Module.

The 10A Relay Module is rated for 10 amps of continuous current. If the dispenser power, including startup current, exceeds 10A then an external high powered relay must be installed to control the dispensers. It is a good practice to wire the dispenser power in a logical order such as Dispenser 1 to Relay Channel 1, Dispenser 2 to Relay Channel 2, etc.

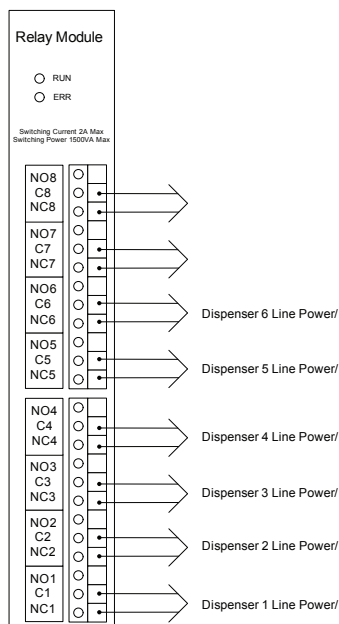

## Dispenser Interface Module

The Dispenser Interface Module (DIM) is a device attached to the Power Supply Module. Connections to the DIM are located on the bottom left side of the Console using the appropriate cable kit based on the dispenser type.

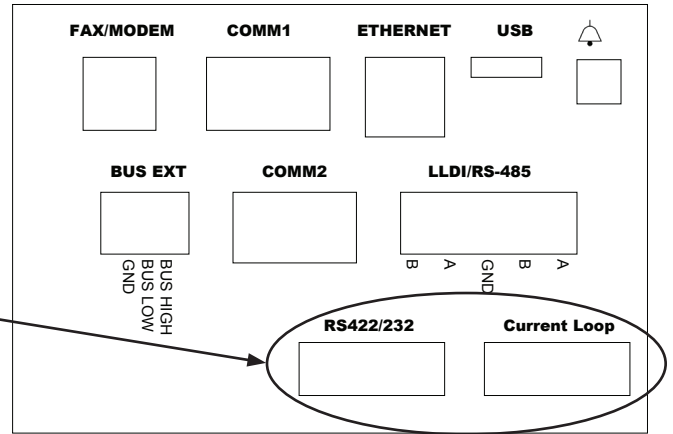

## Ullage Volume Input

The console can gather ullage volume from either the internal inventory probes or from existing inventory probes through an External ATG.

### Using Internal Magnetostrictive Probes

To use internal magnetostrictive probes, you must have Fuel Management System (FMS) enabled in the registration. See the *TS-5xxx Programming Manual* for instructions for programming the FMS section. The FMS section must be programmed before the VRM section.

### Using an External ATG

There are certain requirements in order to retrieve ullage volume from an external ATG.

- Continuous access to a RS-232 connection
- Ability to respond to the following serial Command:
  - Command: **i201TT** - *In-Tank Inventory Report, TLS-350 command set*
  - Command: **10T** - *Inventory Report, TLS-250 command set*
- Serial Cable with the following specifications:
  - Cable must be a 'Null' Serial
  - DB9 Male (INCON Console) to either DB25 Male or DB9 Male (ATG)

Use the following steps to connect an External ATG to a Console:

1. Connect the DB9 female end of the cable to Comm 2 on the Console.
2. Connect the other end of the cable to the serial port of the External ATG.
3. Set the serial port parameters to match between the Console and the External ATG, see *TS-5xxx Setup Programming Guide*.
4. Validate there is no "External ATG Communication" alarm.

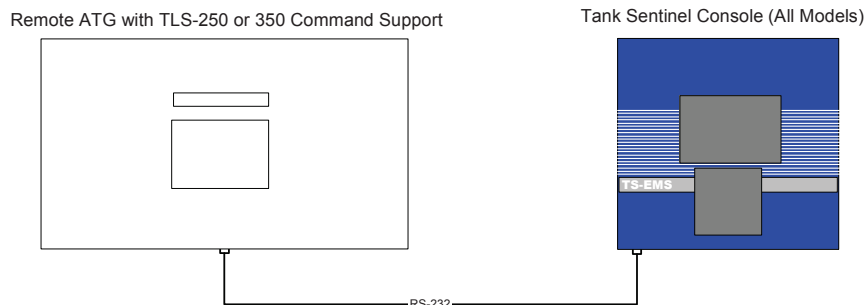

**Note:** A DB25 to DB9 Null Serial Cable may be purchased from INCON, PN 600-0099. See the *TS-5xxx Series Installation Manual* "Communication Ports" section for pinouts of Comm Port 2.

# Setup and Programming

## Startup

Upon completing the installation of the Vapor Recovery Monitoring (VRM) System and powering up the Console, programming the setup is the next step.

## System Status

The Console will arrive at the site with the VRM application already enabled. Upon first powering up the console you may see a screen that looks like the one in Figure 2a. The system with the screen in Figure 2a has the VRM application as well as the Fuel Management System (FMS) application enabled. These applications are set by a registration key at the time of purchase.

The first step before programming the VRM is to check to see if all the modules are powered up and operational. Select the **System** box which brings up the **System Status** page as shown in Figure 2b.

Figure 2a and 2b

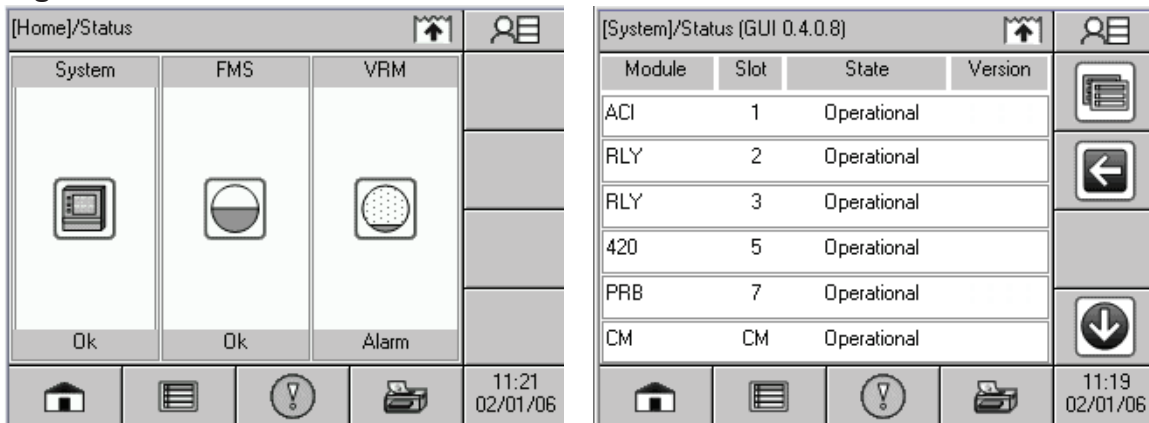

Verify all the modules are present and operational. If all the modules are “Operational” then you may proceed to setup and programming. If not, refer to the Alarm Codes and Troubleshooting section of this manual.

## Programming the Console for Vapor Recovery Monitoring

The following programming instructions are specifically intended for the Vapor Recovery Monitoring (VRM) System. For additional programming refer to the *TS-5xxx Programming Manual* (p/n 000-2142). This manual covers both the hardware programming and the application programming. The method shown below is the same whether the user programs through the local touchscreen or a Web Browser. Inclusion of other options like the FMS application, Dispenser Hook Isolation and Line Leak Detection (LLD) will effect the programming of the VRM system. The *TS-5xxx Programming Manual* (p/n 000-2142) describes the proper programming and sequencing for the console setup. The following sections show how to program the setup as it relates to the VRM system. Contact Franklin Fueling Technical Support at 800-984-6266 for assistance with these applications.

## Data Transfer Units

This is an optional hardware interface to communicate the VPS and VFM and Dispenser Shutdown over existing dispenser AC power line. If a TS-DTU was installed then the following setup is required.

Group Name	Parameter Name	Parameter Value	Explanation
Remote Data Transfer Units	Network ID	1	Leave as default. In rare circumstances the network ID may need to change if another network is near.
Dispenser Configuration	Number of Units	1	Enter the number of DTU Modules at the dispensers. This does not include the console DTU.
TS-DTU 1	Unit ID	14-EEA8-FFFF-0000-1A	This is the unique ID located on the DTU label. The console uses this ID to know which modules to communicate with.

## Dispenser Hooks Mapping

Mapping the gasoline dispenser hooks signals correctly is important for the VRM to properly identify active fueling points. The dispenser hooks must be wired correctly as explained in the *TS-5xxx Installation Guide* (p/n 000-2150).

**Note:** Dispenser Hook Signals are only required on installations prior to VRM Version 1.2.0.

Group Name	Parameter Name	Parameter Value	Explanation
AC Input Modules	Number Gasoline Hooks per dispenser	0	Set to zero if not using dispenser hook signals, otherwise the number of gasoline hooks coming from each dispenser
Module #	Channels	(n)	Select number of gasoline dispenser hook signals available from each dispenser. The Vapor Recovery Monitor does not use any non-gasoline products.
Channel #	Name	Ex. Dispenser 1 Hook Regular	Unique name for the hook signal
	Enabled	Yes	Select "Yes"
	Active High	Yes	Set to "Yes"

## Vapor Flow Meter Select

The Vapor Flow Meter (VFM) select is located under the Probe Module. This is where we define the number of input channels and select the VFM. Go to the Probe Module setup and make the following changes. If the FMS application is also running, some of the channels will be designated for probes.

Group Name	Parameter Name	Parameter Value	Explanation
Probe Modules			
Module #	Channels	(n)	Select the number of flow meters/probes at the site
Channel #	Name	Ex. VFM Disp 1	Unique name for Vapor Flow Meter
	Enabled	Yes or No	Set to "Yes"
	Type	TS-VFM	Select Vapor Flow Meter type

## Vapor Pressure Sensor Select

The Vapor Pressure Sensor (VPS) Select is located under the 4-20mA module setup. This is where we define the input channel and select the VPS. Go to the 4-20mA Module setup and make the following changes. If Electronic Line Leak detection is being installed, some channels will be used for the LLD transducers.

Group Name	Parameter Name	Parameter Value	Explanation	
<b>4-20mA Input Modules</b>				
	Module #	Channels	(n)	Select "1" for the Vapor Pressure Sensor
	Channel #	Name	Ex. ISD Pressure Sensor	Unique name for VPS
		Enabled	Yes	Keep as "Yes"
		Service Type	Vapor Recovery Monitor	Select correct service type for application

## Remote ATG Serial Port Settings

If the Console will be getting ullage volume from a Remote ATG then the serial port must match that of the other tank gauge.

Group Name	Parameter Name	Parameter Value	Explanation	
<b>Power Supply Module</b>				
	COMM 2	Baud Rate	9600	Set to match External ATG
		Data Bits	8	Set to match External ATG
		Parity	None	Set to match External ATG
		Stop Bits	1	Set to match External ATG
		Response Timeout	8	Leave as default

## Relay Mapping

Relay mapping is necessary for proper shutdown of dispensers. The programming of the Relay Module will tell the VRM which Vapor Flow Meter will control which Dispenser. As you will see this is why we enter a unique name for each Flow Meter so we can easily identify the channel.

**Note:** By mapping the relay to the VFM in the following setup, we now enable the VRM to automatically shutdown dispensing upon ISD alarms.

Group Name	Parameter Name	Parameter Value	Explanation	
<b>Relay Module</b>				
	Module #	Channels	(n)	Select number of dispensers
	Channel #	Name	Dispenser 1 Power	Unique name for relay's purpose
		Enabled	Yes	set to "Yes"
		Type	Dispenser	
		Polarity	Normal	Set to Normal
		Logic	OR Logic	Set to OR
		Physically Wired As	Normally Closed	Set to Normally Closed
		Number of Inputs	1	Set to 1
	Input 1	Type	Probe Module	Select Probe Module
		Channel	VFM Disp 1	Select the VFM associated with this Dispenser

Additional relays may be used for other purposes such as submersible pump control or external alarms. See the *TS-5xxx Installation Guide* (p/n 000-2150) for more information.

## Dispenser Interface

The Dispenser Interface setup is where the Dispenser Interface Module is programmed. For this setup, you will need to know what kind of D-Box the Dispenser Interface module is connecting up to and what type of communication interface it is using. For more information on the installation and setup of the Dispenser Interface Module, see the TS-5xxx Installation Manual and TS-5xxx Setup and Programming Manual.

Group Name	Parameter Name	Parameter Value	Explanation	
<b>Dispenser Interface</b>				
Precision	Volume Precision	3	Leave as default	
	Dispenser Volume	Gross	Leave as default	
Grades	Number of Grades	3	Select number of different gasoline only grades at facility	
	Grade 1	Name Include in Vapor recovery	Regular Unleaded Yes	Enter a Name for the Grade
	Grade 2	Name Include in Vapor recovery	Premium Unleaded Yes	Enter a Name for the Grade
	Grade 3	Name Include in Vapor recovery	Super Unleaded Yes	Enter a Name for the Grade
Dispenser Interface Modules				
DIM 1	Type	Wayne		
	Communication	Current loop		
Fueling Points	Number of Fueling Points	12	Enter the number of gasoline fueling points	
Fueling Point 1	Number of Hoses	3		
	Hose 1 QC	Grade Association	Regular Unleaded	Enter a Name for the Grade
Position		0	Select position of Grade	
Hose 2	Grade Association	Premium Unleaded	Enter a Name for the Grade	
	Position	1	Select position of Grade	
Hose 3	Grade Association	Super Unleaded	Enter a Name for the Grade	
	Position	2	Select position of Grade	
Fueling Point 2	Number of Hoses	3		

## Vapor Recovery Monitoring Setup

This is the final setup to get the Vapor Recovery Monitor (VRM) to work properly. This is where we select the type of vapor recovery system and call in the appropriate external sensors.

Group Name	Parameter Name	Parameter Value	Explanation	
<b>Vapor Recovery Monitor</b>				
	Method Type	Balance or Assist	Select the type of EVR system installed.	
	Hour Assessment	0	Set time of VRM alarm action	
	Week Day Assessment	Sunday	Set Day of VRM alarm action	
Dispenser Configuration	Dispenser Type	Wayne or Gilbarco	Select the dispenser model	
	Multihose Dispenser Site	No	Select yes or no	
	Number of Dispensers	0 (1 to 48)	Equal to the number of flow meters installed	
	Dispenser 1	Flow Meter	Unique Name	Select Meter by name from list of enabled meters
		First Fueling Point	1	Select correct fueling points for dispenser number.
	Second Fueling Point	2	Select correct fueling points for dispenser number.	
Ullage Pressure Input	Sensor	Sensor name	Select the correct sensor name	
Ullage Volume Input	Acquire Ullage	Internal, external	Select internal if using LL2 probes or external if connected to remote ATG.	
	Security Code	#		
	Number of tanks			
Tank 1 Ullage	Enabled	Yes or No	Select Yes if part of EVR System	
	Enabled	Yes or No	Select Yes if part of EVR System	
Pressure Management System	Enabled	Yes or No	Yes	
	Type	Clean Air Separator	Select appropriate device	

## Managing Rules

Alarms will be generated automatically and can be seen on the touchscreen display or the Alarm pages on the web browser. These alarms can be programmed to generate various outputs based on the Rules setup.

**Note:** VRM alarms will automatically disable dispensers and this feature cannot be turned off per CP-201 requirements.

Additional actions can be created by setting up Rules. Rules are the way to create actions and notifications based on specific events change. Events are the inputs to the rule, for example it can be a failed test or a sensor gone bad, but it can also be a simple test completion notification. Actions are the outputs for the Rules, for example you can program the console to send emails, trip relays, or sound alarms. The Rules are entirely flexible and allow stations owners to customize the alarm notification process.

There are three default rules enabled on the Console. These rules all have actions to sound the internal audible alarm. These rules can be disabled or can have their action changed. New Rules can be added for complete customization for notification. Below is an example of a new rule that emails a notification on any new VRM alarm. A more descriptive explanation on Rules can be found in the *TS-5xxx Programming Guide* (p/n 000-2142).

### Rules

Variable	+ or -	Explanation
<b>Rules</b>	+	
Rule – Power On »		Default Rule, Internal audible alarm output
Rule – Application Events »		Default Rule, Internal audible alarm output
Rule – New Alarm Occurred »		Default Rule, Internal audible alarm output
Rule – New Rule #1	-	
Name		Enter a name for the rule. Once entered, the name will appear next to the above Rule.
Enabled		Select whether the rule is to run or not
Events	+	By pressing the + sign, you can have one or multiple events
Event	-	Below is an example of a new rule to send an email for any new VRM alarms
Type		Select “New Alarm Occurred”
Category		Select VRM
Code		Select “Any”
Device		Select “Any”
State		Select “Active”
Actions	+	
Action	-	
Type		Select “E-Mail” (See next section for setting up email notification)
Address		Enter in your email address
Content		Select “Generated” to have the Console automatically produce the contents in the email. Otherwise you can have the email contain exactly what you specify.
Template		Select “HTML”. You can have either a text or HTML email.



## Setting Up E-mail Notification

The E-mail notification is a feature that allows store owners and managers to receive e-mails from their console. These e-mails include alarms, events and test results. In order for the system to send e-mails and text messages based on the Rules configurations, certain parameters need to be configured. These parameters will tell the console how to transmit e-mails to the outside.

### Email

Variable	Description
<b>"From" Address</b>	Unique e-mail address to identify the VRM console (e.g. Site@city.state)
<b>SMTP Host</b>	This is to be provided by network administrator or ISP
<b>SMTP Port</b>	Check with network administrator or ISP
<b>Enable Authentication</b>	Some e-mail providers require authentication in order to send e-mails. See Internet Service Provider
<b>Maximum Queue Size</b>	The number of e-mails that can be waiting to be sent
<b>Retry Timeout</b>	The number of seconds to wait between failed tries. Default is 3600 seconds or 1 hr.
<b>Watchdog Timeout</b>	This is the inactivity timeout.

# System Operation

## Run-Time Status

The VRM application has several useful run-time menus to check status or to get current test status.

### Home»Status

The home-status page shows the current status of all applications running in the Console, see Figure 3. Depending on the applications that are running on the console, the Home-Status will display only the ones enabled. In Figure 3 below, we have FMS (Fuel Management System), and VRM (Vapor Recovery Monitoring). At anytime you can get to the Home Status menu by pressing the **Home Box**.

**Figure 3 – Home Status LCD View**

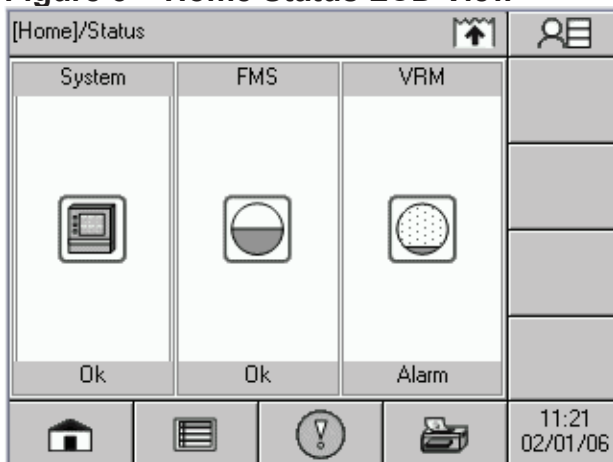

### System»Status

The System-status window shows the state, slot location, and module version number of each module inside the physical console.

### VRM»Status

The VRM-Status window gives the current status of each Vapor Flow Meter, pressure sensor, and other VRM related data. See Figure 5b.

## Vapor Recovery Web Pages

### VRM Status Page (Web Page View)

The **VRM»Status** page will show up to date status for each fueling point. The status is based on the previous days results. In the Current Status column a Pass ( ✓ ), Failure ( X ), Warning ( ! ), or Insufficient ( \* ) symbol will show up for each fueling point. The final assessment for each fueling point will occur at the end of the day and can be viewed in the ISD reports. The following describes the remaining information in the VRM status page. Refer to Figure 4 - VRM Status Page.

**Auto Refresh:** The LCD automatically refreshes the screen with the latest data. Using the web version, the VRM Status page has an optional Auto Refresh mode and can be enabled by selecting the "Auto Refresh" link in the upper right-hand corner. The default refresh rate is set to 30 seconds but can be changed to a faster or slower rate. To change the refresh rate go to the **Preferences** page.

**Dispenser:** This is the dispenser number as associated with the Point of Sale system.

**Dispenser Status:** Shows the activity of the dispenser, Idle (or inactive), Dispensing, or Shutdown. This status is linked to the dispenser hook signals only.

**TS-VFM:** Shows the state of the vapor flow meters and is only in the web-based view. There are four possible states:

Operational – The VFM has no alarms

Missing – The VRM has lost communication with the vapor flow meter. This may occur during an open circuit or the vapor flow meter is not installed on the port in which it was programmed for.

No Data – The VRM is unable to understand the input data. This may occur when a port is programmed for a flow meter but a magnostrictive probe is connected instead.

Error – The flow meter data was not sent correctly. This may occur when with excessive noise in the system or it is an indication that the flow meter is not functioning correctly.

**Fueling Point:** This is the assigned fueling point number from setup.

**Daily Status:** The daily status shows the last completed daily assessment for each fueling point/hose. One of four symbols will be displayed for each fueling point/hose.

**Weekly Status:** The weekly status shows the last completed weekly assessment for each fueling point/hose.

**Last A/L:** This value is the fueling point's last calculated A/L ratio result. The value is based only on a single transaction.

**Figure 4 - VRM Status Page**

Franklin Fueling Systems		VRM Status				
Home System VRM Setup Preferences						Auto Refresh
Status Alarms Control Reports						07/13/2009 12:13:49
Dispenser	Dispenser Status	TS-VFM	Fueling Point	Daily Status	Weekly Status	Last A/L
1	Idle	Operational	1	✓	✓	0.49
			2	✓	✓	1.01
2	Dispensing	Operational	3	✓	✓	0.55
			4	✓	✓	0.68
3	Idle	Operational	5	✓	✓	0.33
			6	✓	✓	0.31
4	Idle	Operational	7	✓	✓	0.55
			8	✓	✓	1.12
5	Idle	Operational	9	✓	✓	0.47
			10	*	✓	0.39
6	Idle	Operational	11	✓	✓	1.12
			12	*	✓	1.20
Common					Value	
Pressure Sensor					Operational	
Ullage Pressure					-7.86	
Weekly Ullage Pressure Leak Test					Pass	
Weekly Ullage Pressure Monitoring					Pass	
Monthly Ullage Pressure Monitoring					Pass	
Operation Time %					100	
Pass Time %					100	
Readiness State					Ready	
Algorithm Version					1.2.0	
Collection Method					Assist	

pass ✓ fail ✗ warning ! insufficient \* disabled ☒

## VRM Status (LCD View)

The LCD view provides the same information as the web page but is broken into two different screens. The VRM-Status on the LCD will show the real time information for the ullage pressure and last run pressure test results as shown in Figure 5a & 5b. The VRM-Dispenser is the second screen which shows current status of the dispensers as shown in Figure 6a & 6b.

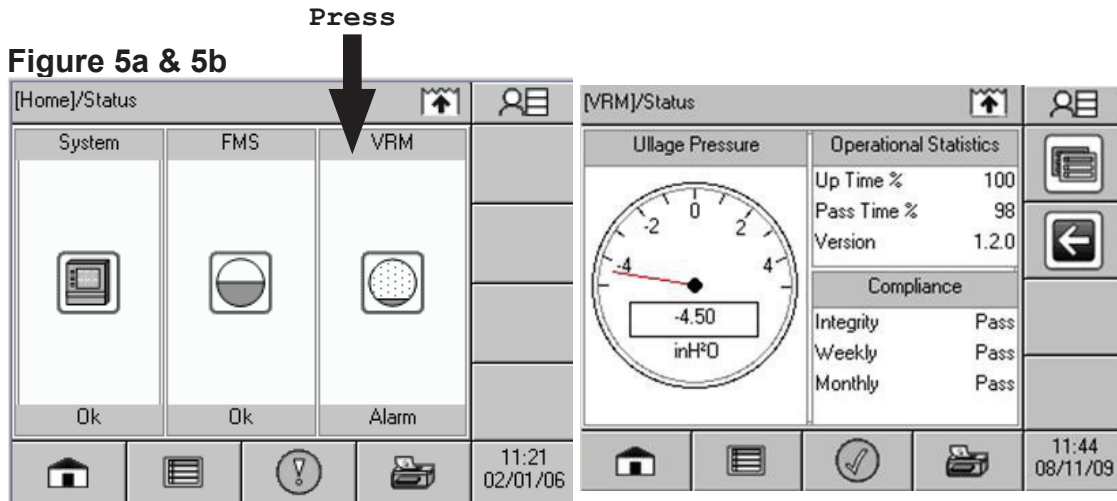

## VRM»Dispensers (LCD View)

By pressing the Application Menu button  in the upper right-hand corner of the **VRM»Status** screen it will bring you to a page of several submenus for VRM. The Status box is the same page as shown in Figure 5b. The Dispensers page will bring up a new page that looks like the one in Figure 6b.

## Figure 6a & 6b

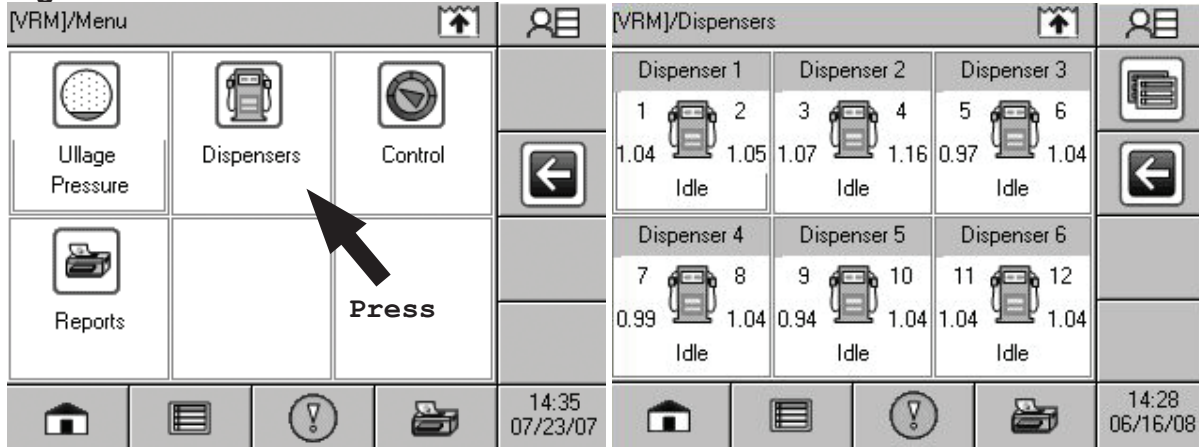

## VRM»Alarms Page (LCD View)

The **VRM»Alarms** page shows all current alarms for the Vapor Recovery Monitor. When an alarm clears it will be removed from this page but will be kept in memory. The Alarm History report will provide information on previous alarms.



↑  
Press

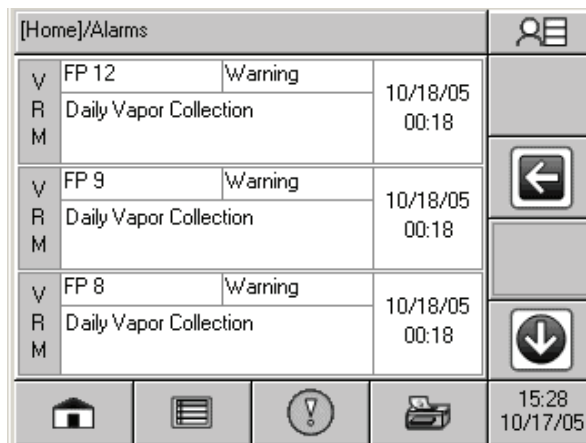

## VRM»Control (LCD View)

The VRM control page is setup to run manual test and calibrate the pressure sensor. These features are described later in this manual.

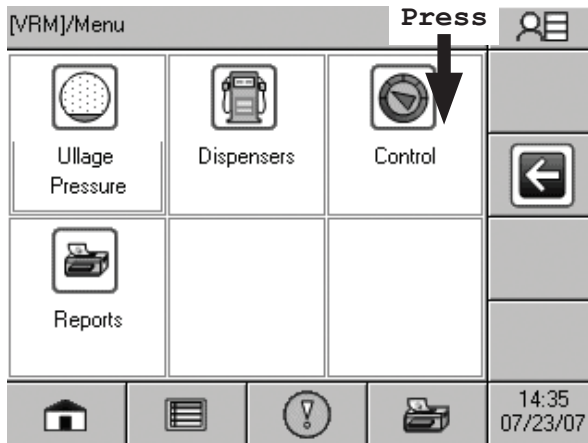

# Alarms, Warnings, and Failures

Alarms, warnings, and failures are designed to alert you with specific details when a problem occurs so that you can take appropriate corrective action. System alarms, VRM alarms, VRM warnings, and VRM Failures will always notify the user in certain ways, other notification options are programmable.





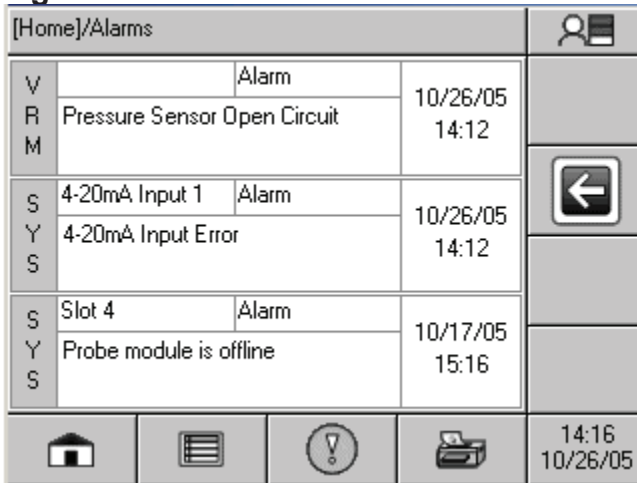

Figure 7 shows an example of two System Alarms, and one VRM alarm. All active alarms can be viewed from the LCD by pressing the Alarm button, , at the bottom of the LCD. Once the alarm goes inactive it will disappear from the **Home/Alarm** page but will remain stored in memory. Any outputs that are programmed to activate based on alarms will go active. These outputs can be customized to activate based on specific alarms or all alarms in the Rules setup.

## System Alarms

System alarms are non-application related alarms. These alarms are usually related to hardware such as an internal module is offline or a printer problem.

Figure 7



[Home]/Alarms				
V R M	Alarm	10/26/05 14:12		
Pressure Sensor Open Circuit				
S Y S	Alarm	10/26/05 14:12		
4-20mA Input 1				
4-20mA Input Error				
S Y S	Alarm	10/17/05 15:16		
Slot 4				
Probe module is offline				
				14:16 10/26/05

## VRM Alarms

Vapor Recovery alarms are hardware problems related to the Vapor Recovery Monitoring application. VRM alarms will be generated immediately with a flashing RED LED. A VRM alarm will not cause a dispenser(s) shutdown.

## VRM Warnings and Failures

VRM Warnings and Failures are monitoring alarms related only to the Vapor Recovery Monitoring application. These Warnings and Failures are directly related to the CP-201 ISD requirement to monitor collection and containment of the vapor recovery system. A VRM warning will occur when either a fueling collection point or the entire vapor containment does not meet the operating thresholds. A warning is the first sign of a vapor recovery problem. A VRM failure will follow the warning if the specific problem with the vapor recovery component does not get fixed within the monitoring time period. This failure will cause either a single or site shutdown, depending on the type. The following provides more detail on the specific warning and failure types.

### Vapor Collection Warning and Failure

Vapor collection warning and failures (A/L) generally occur due to poor or no vapor being returned to the underground storage tank during fueling transactions. The VRM system makes both a daily and weekly assessment on the quantity of the vapor collection. If the collection is below the lower failure limit or above the higher failure limit, then the VRM will go into alarm.

Upon a Vapor Collection Warning condition, it is highly recommended to get the fueling point(s) serviced as soon as possible. If a fueling point goes untreated, then the VRM will issue a failure alarm and shut down the affected dispenser. If this condition occurs, the entire dispenser should be placed out of service until a Franklin Fueling Systems certified technician can troubleshoot the problem. All other dispenser will remain in operation. See Appendix A for the Alarm Code description and possible solution, or the *Vapor Recovery Monitoring Troubleshooting and Diagnostics Guide* available on the Franklin Fueling Systems Web site: [www.franklinfueling.com](http://www.franklinfueling.com).

## Vapor Pressure Containment Warnings and Failures

A Weekly or Monthly Ullage Pressure warning or failure occurs when the vapor pressure exceeds the operating threshold. The VRM system makes both a weekly and monthly assessment on the amount of time the vapor containment pressure exceeds a threshold over a specific period of time. If the containment pressure rises above the overpressure limits for either the weekly or monthly thresholds, then the VRM will issue a warning. A second consecutive period of exceeding the overpressure threshold will result in a failure alarm and a shutdown of all dispensers.

A Weekly Ullage Pressure Leak Test warning or failure is an indication that the containment space (vapor space) is leaking vapors beyond the allowable limit. This assessment is performed on a weekly basis. If a vapor containment is leaking, the VRM will issue a warning at the end of the first week and if it is not fixed by the end of the second week then all dispenser will become disabled.

See Appendix A for the Alarm Code description and possible solution, or the *Vapor Recovery Monitoring Troubleshooting and Diagnostics Guide* available on the Franklin Fueling Systems Web site: [www.franklinfueling.com](http://www.franklinfueling.com).

## Re-enabling Dispenser(s)

Dispensers can be re-enabled by the following method. Note that this procedure does not clear any warnings or failures, it only re-enables dispensing.

**Warning**  **The Failed fueling point requires immediate attention and should be bagged so it is not used until the problem has been fixed by a certified Service Technician. Continuous use of a failed Fueling Point will result in another shutdown.**

**Warning**  **Refer to local districts before putting a shutdown dispenser back into operation.**

### From the LCD:

1. Go to the **VRM»Dispensers** menu (see Figure 5a & 5b and Figure 6a & 6b).
2. Press the dispenser showing “Shutdown”.
3. Press “Yes” on the confirmation box.

### From the Web Browser:

1. Go to the **VRM»Status** page.
2. Press the red “Shutdown” for each dispenser showing shutdown.
3. Press “Yes” to enable the dispenser or all dispensers.

Franklin Fueling Systems			VRM
Home System FMS VRM Setup Preferences			
Status Alarms Control Reports			
Dispenser	Dispenser Status	TS-VFM	
1	Idle	Operational	
2	Idle	Operational	
3	Idle	Operational	
4	Shutdown	Operational	
5	Idle	Operational	
6	Idle	Operational	
Common			
Pressure Sensor			
Ullage Pressure			

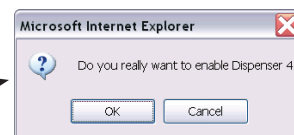

**Note:** If a dispenser shutdown was caused by poor vapor collection, you will only be able to enable one dispenser at a time. If the shutdown was caused by a pressure failure, you will be able to enable all dispensers at the same time by pressing any dispenser.

## Clearing Alarms

Vapor Flow and Vapor Pressure alarms can be cleared by running the respective manual test or by waiting until the next assessment period has passed.

### Clearing Vapor Collection (A/L) Alarms

Once a certified technician has fixed the cause of the vapor flow problem, the alarm can be cleared by two methods: running a manual test or letting the fueling point go through a full day of transactions. The manual A/L test is much faster and will allow the technician to clear the alarm before leaving the site. To run a manual test, go to **VRM»Control** then select “**Manual A/L Test**”. Now select the fueling point(s) that are in alarm and on the next dispense, if there is an A/L passes then the alarm will clear. See Figure 8a & 8b.

**Figure 8a & 8b**

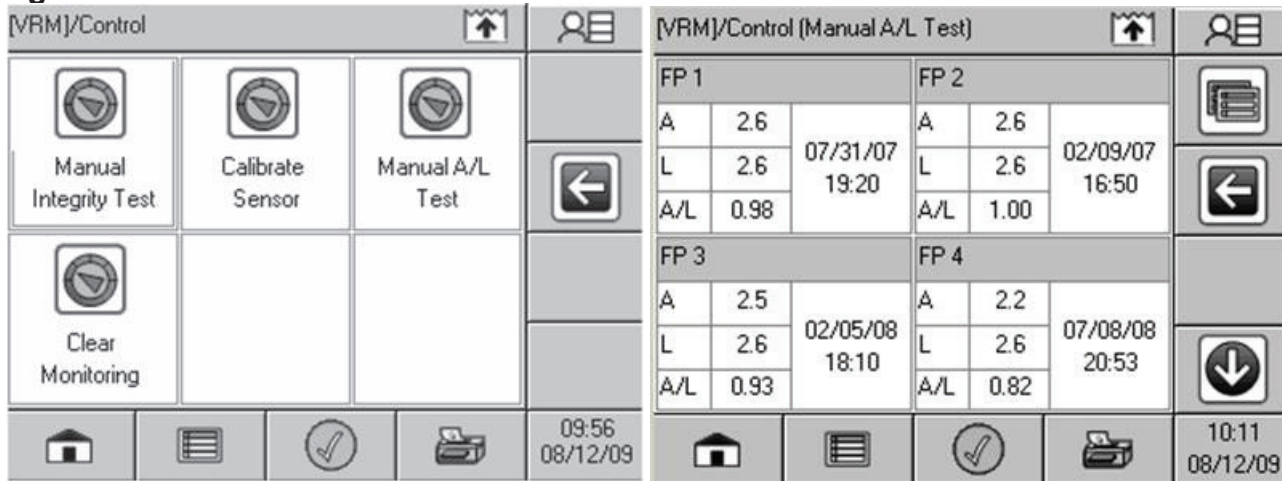

**Note:** The manual A/L test should be done on either a known non-ORVR vehicle or test container that will return air/vapor mixture back to the UST. If the A/L does not meet the required threshold then the fueling point will remain in alarm.

### Clearing Pressure Related Alarms

A technician will also have two methods of clearing pressure related alarms by either letting the system go through its normal assessment period or manually clearing pressure alarms.

To clear a Pressure Related Alarms, do the following:

1. Go to the **VRM»Control** Page and select “**Clear Monitoring**”.
2. Enter in your Franklin Fueling Systems technician ID number.
3. Enter in the administrator password.
4. All the Pressure Monitoring Alarms shall clear.



# Reports & Printing

## Creating Reports

Reports can be generated and printed based on the last 30 days, by month, or by year. The console stores ISD history for two years.

Figure 9a and 9b - VRM Reports LCD View

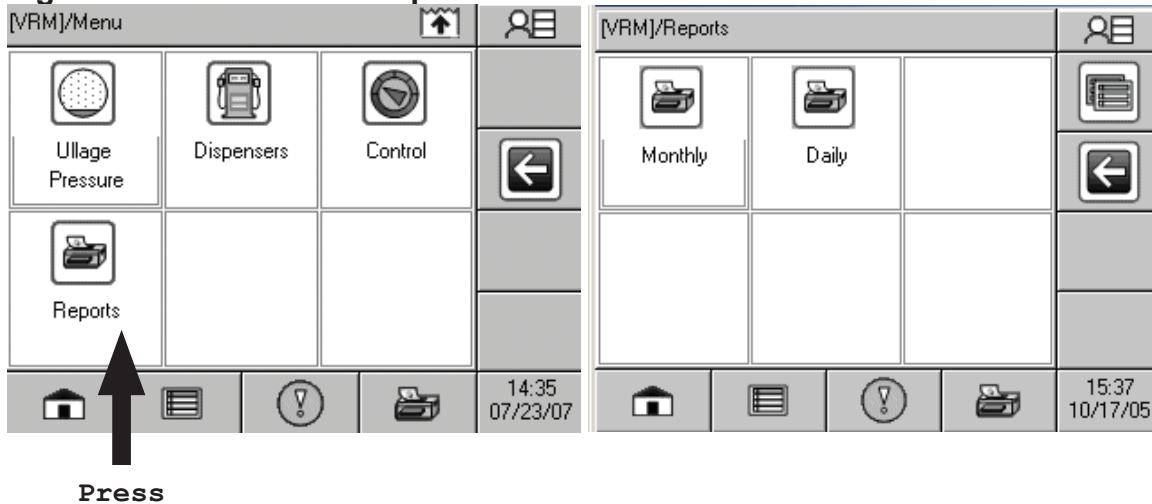

### Alarm Reports

Alarm reports can be generated either from the **System»Reports** page or the **VRM»Alarms** web page. The **System»Reports** page will generate both the system alarms and application alarms while the **VRM»Alarms** will only generate VRM related application alarms.

### VRM Reports

There are two different VRM reports that can be generated, a Daily Report and a Monthly Report. The Daily Report generates a list of results for each day on a rolling 30 day basis. The information included in the report is:

#### Daily Report

##### ISD Up-Time

The ISD up-time is the percentage that the ISD System is running the VRM application. It calculates the up-time based on actual run-time during a 24-hour period. It is stated in CP-201 that the ISD system must be running 95% of the time on an annual basis.

##### Highest and Lowest Ullage Pressure

The highest and lowest ullage pressure is the highest and lowest average hourly pressure for each day.

##### 75<sup>th</sup> and 95<sup>th</sup> Percentile Ullage Pressure

The VRM records and stores the 75<sup>th</sup> and 95<sup>th</sup> highest ullage pressure for each day.

##### Fueling Point Assessments

This shows the daily status of each fueling point. There are four assessments that each fueling point can be classified into; pass, failure, warning, or insufficient data.

## Monthly Report

### ISD Operation Time, %

The ISD operation time is the cumulative operation time of the VRM application. It is stated in CP-201 that the ISD system must be running 95% of the time on an annual basis.

### EVR Operating Requirements

The EVR operating requirements list what EVR components are installed at the site and what each component should be operating at if applicable.

### EVR Pass Time, %

The EVR pass time is the percentage of time the entire EVR system is not in an Alarm state.

### ISD Monitoring Requirements

The ISD monitoring requirements are the limits in which alarms are triggered by.

### Warning, Failures

This is a list of current and past warnings and failures that relate to VRM.

### Event Log

The event log shows a description of any shutdowns and the action to re enable any fueling points.

## Printing Reports

### **Printing from a Web Browser**

Printing reports can be done directly from the web browser. Once a report is generated it can simply be printed by going to the **File>Print** on the on the web browser's tool bar.

### **Printing from the Local LCD**

To print from the local LCD to the internal printer, press the print button  and it will navigate you to the print menu. From the print menu, you can choose the type of report you want to print.

Printed VRM Report Examples

```

{Site Name}
{ID Line 1}
{ID Line 2}
{ID Line 3}
{ID Line 4}
{ID Line 5}
12/26/2008      11:25:39

VRM Daily Report
From: {date}
To:   {date}

Pressure: inH2O
ISD Version: 1.2.0
ISD Up Time 100%

12/26/2008
ISD Up Time      100.00
ISD Pass Time    0.00
Pressure Max     0.26
Pressure Min     -2.53
Pressure 75th   -0.77
Pressure 95th   -0.11

FP1      P0.98
FP2      P1.03
FP3      P1.03
FP4      P1.05
FP5      P0.98
FP6      P1.01
FP7      P1.01
FP8      P1.05
FP9      P0.97
FP10     P1.02
FP11     P1.03
FP12     P1.05

12/25/2008
ISD Up Time      100.00
ISD Pass Time    0.00
Pressure Max     0.22
Pressure Min     -2.67
Pressure 75th   -0.90
Pressure 95th   -0.21
FP1      P0.98
FP2      P1.03
FP3      P1.03
FP4      P1.05
FP5      P0.98
FP6      P1.01
FP7      P1.01
FP8      P1.05
FP9      P0.97
FP10     P1.02
FP11     P1.03
FP12     P1.05
    
```

```

{Site Name}
{ID Line 1}
{ID Line 2}
{ID Line 3}
{ID Line 4}
{ID Line 5}
12/20/2005      11:25:39

VRM Monthly Report
From: {date}
To:   {date}

Statistics
December 2005
Operation [%]
100
Pass [%]
100

Operation Requirements
Vapor Collect Method
Assist
A/L Low
0.95
A/L High
1.15

Monitoring Requirements
Dry Vapor Coll. A/L
Low
0.33
High
1.90

Wkly Vapor Coll. A/L
Low
0.81
High
1.32

Wkly Ullage Press. Mon.
High
1.30

Mthy Ullage Press. Mon.
High
0.30

Warning Alarms
Occurred
12/09/2005      00:05:00
Cleared
12/10/2005      02:15:00
Daily Vapor Collection
Fueling Point 10

Failure Alarms
11/27/2005      00:00:05
Weekly Ullage Pressure Leak

Events
Occurred
12/20/2005      07:07:14
    
```

# **Maintenance**

## **General Inspection**

Maintenance is not required on the ISD equipment. All ISD Vapor Flow Meters and Vapor Pressure Sensors are checked every day for proper operability. The Console also does a self-check on all the internal modules as well on a daily basis.

If the Console identifies a problem with any components or Vapor Recovery Sensors, they will need to be diagnosed. See the replacement part numbers for the failed component and contact Technical Service.

## **Console and Vapor Recovery Equipment Replacement Parts**

<b>Part Number</b>	<b>Description</b>
TS-PRB	12 Input Probe Module
TS-420IB8	8 Input 4-20ma Module
TS-RLY	8 Channel Relay Module
TS-ACI	12 Channel AC Input Module
TSSP-CM	Control Module
TSSP-PS	Power Supply Module
TSSP-LCD	LCD Display
TSSP-IFB5X	TS-550/EMS Interface Board
TSSP-IPPTR	Impact Printer Assembly
TSSP-T550MB	TS-550/EMS Motherboard
TSSP-T5000MB	TS-5000 Motherboard
TS-VFM	Vapor Flow Meter
TS-VPS	Vapor Pressure Sensor
TS-DIMIB	Internal Dispenser Interface Module
TSP-ENCD	Flow Meter Encoder Replacement
TSSP-BAT	3V Lithium Battery
TSSP-F4	Fuse, 3A (Relay and Power Supply)
TSSP-ISBS	I.S. Barrier Shield
TS-TP5000	TS-EMS/550/5000 Impact Printer Paper
TS-INKRB	TS-EMS/550/5000 Inker Ribbon
TSSP-TRMBLK	Package of 10 Terminal Blocks
TSSP-TMPTR	Thermal Printer
TS-TP2	Paper for the Thermal Printer (1 box of 5)

# Diagnostics

## Pressure and Transaction Log Files

The console records pressure and transaction data on a continuous rolling basis. There are two .csv (comma separated values) files that can be downloaded from the VRM download page. These files are Microsoft Excel compatible and can be used as a diagnostics tool to help troubleshoot sites.

**Note:** This feature is only available in VRM Version 1.2.0 or higher.

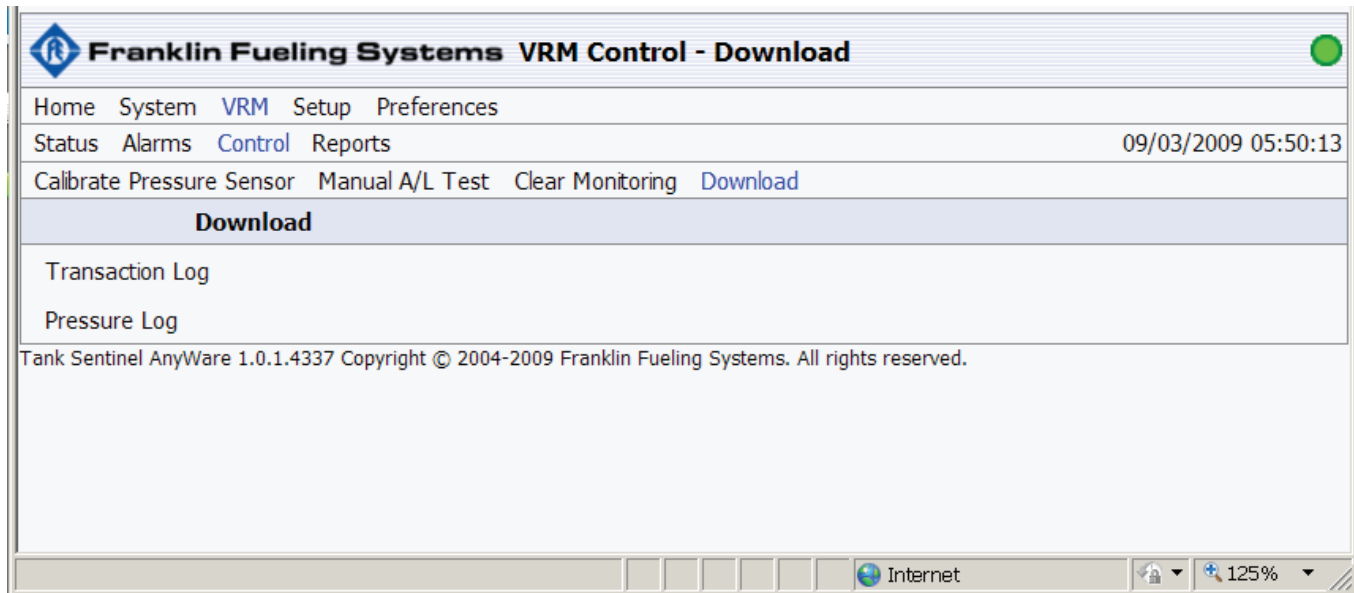

## Pressure Log Files

The pressure log file contains 2 weeks of pressure samples in one minute increments. Below is an explanation of the columns in the pressure log file.

Term	Description
<b>DATE_LOCAL</b>	This column is the date the pressure sample was recorded.
<b>TIME_LOCAL</b>	This column is the time the pressure sample was recorded.
<b>QUIET_TIME</b>	This value indicate if there was active dispensing at the time of the sample. A "1" indicates at least one fueling point is dispensing and a "0" indicates no fueling points are dispensing.
<b>PRESSURE</b>	This is the pressure sample recorded by the console. The Vapor Pressure Sensor has a range between -8 Inches WC and +8 Inches WC. The pressure value may reach as far as 9 Inches WC, this is ok.
<b>ULLAGE</b>	The ullage is the amount of vapor space in the vapor containment area. The units are in gallons.

	A	B	C	D	E	F
1	DATE_LOCAL	TIME_LOCAL	QUIET_TIME	PRESSURE	ULLAGE	
2	8/15/2009	20:05:00	0	-8.92	19645	
3	8/15/2009	20:06:00	0	-8.92	19645	
4	8/15/2009	20:07:00	0	-8.90	19646	
5	8/15/2009	20:08:00	0	-8.90	19646	
6	8/15/2009	20:09:00	0	-8.88	19646	
7	8/15/2009	20:10:00	0	-8.84	19646	
8	8/15/2009	20:11:00	0	-8.84	19646	
9	8/15/2009	20:12:00	0	-8.84	19646	
10	8/15/2009	20:13:00	0	-8.82	19646	

## Transaction Log Files

The transaction log file records and stores 1000 transactions per fueling point.

Term	Description
<b>HOSE</b>	This column indicates the hose or fueling point number the transaction occurred on. The value shown is a combination of fueling point number and hose number. The right two digits indicate the hose number and the left digits indicate the fueling point number. For uni-hose dispensers, the right two digits can be ignored. You will see a 100 for fueling point 1, 200 for fueling point 2, etc. For multi-hose dispensers, you will see values such as 101 indicating fueling point 1 hose 1 or 703 indicating fueling point 7 hose 3.
<b>DATE_LOCAL</b>	This column is the date at the beginning of the transaction.
<b>TIME_LOCAL</b>	This column is the time at the beginning of the transaction. The time is a local reference to the console.
<b>AIR_VOLUME</b>	This column is the air or vapor returned through the ISD flow meter. The units are in gallons.
<b>LIQUID_VOLUME</b>	This is the amount of gasoline that was dispensed during the transaction. The units are in gallons.
<b>RATIO</b>	This is the A/L ratio of the transaction.
<b>TYPE</b>	This is the classification of the transaction. Only v_VrmValidAoL type transactions are used as part of the daily and weekly average: <b>v_VrmValidAoL</b> is a single transaction that was either less than 0.15 or greater than 0.50. <b>v_VrmORVRPotential</b> is a single transaction that was between 0.15 and 0.50. <b>v_VrmMultipleTransactions</b> is when both sides of a dispenser were active at the same time. <b>v_VrmDispenseVolumeZero</b> occurs when no liquid volume is dispensed. This may occur when a transaction is aborted before pumping any fuel. <b>v_VrmSmallFuelVolume</b> occurs when less than 1 gallon of gasoline is dispensed. <b>v_VrmTransactionLost</b> occurs when the console does not receive the volume of gasoline dispensed from the dispenser or a new transaction occurs too quickly. <b>v_VrmReferenceTest</b> is assigned to a transaction when the transaction is being run as part of a Manual A/L. This is usually done when clearing vapor collection alarms.

Below is an example of a transaction log file.

	A	B	C	D	E	F	G
1	HOSE	DATE_LOCAL	TIME_LOCAL	AIR_VOLUME	LIQUID_VOLUME	RATIO	TYPE
2	101	8/15/2009	20:16:13	6.43	6.46	1.00	v_VrmValidAoL
3	301	8/15/2009	20:18:28	3.88	17.82	0.22	v_VrmORVRPotential
4	703	8/15/2009	20:19:41	3.71	3.45	1.08	v_VrmValidAoL
5	802	8/15/2009	20:21:31	1.57	5.17	0.30	v_VrmORVRPotential
6	401	8/15/2009	20:21:52	0.52	3.23	0.16	v_VrmORVRPotential
7	201	8/15/2009	20:23:28	2.68	4.68	0.57	v_VrmValidAoL
8	101	8/15/2009	20:25:47	12.42	13.53	0.92	v_VrmValidAoL
9	701	8/15/2009	20:25:53	2.22	6.45	0.34	v_VrmORVRPotential
10	101	8/15/2009	20:30:22	10.77	12.91	0.83	v_VrmValidAoL
11	201	8/15/2009	20:32:58	3.95	10.63	0.37	v_VrmORVRPotential
12	501	8/15/2009	20:34:02	16.53	20.12	0.82	v_VrmValidAoL
13	401	8/15/2009	20:34:28	2.62	14.04	0.19	v_VrmMultipleTransactions

## Steps to download log files

1. Navigate to the VRM>Control>Download web page.
2. Click on either the Transaction Log file or Pressure Log file.
3. A message box will appear asking if you want to Open, Save, or Cancel. If you choose to save, you will be prompted to save it to a directory of your choice. The file may take up to five minutes to completely download.

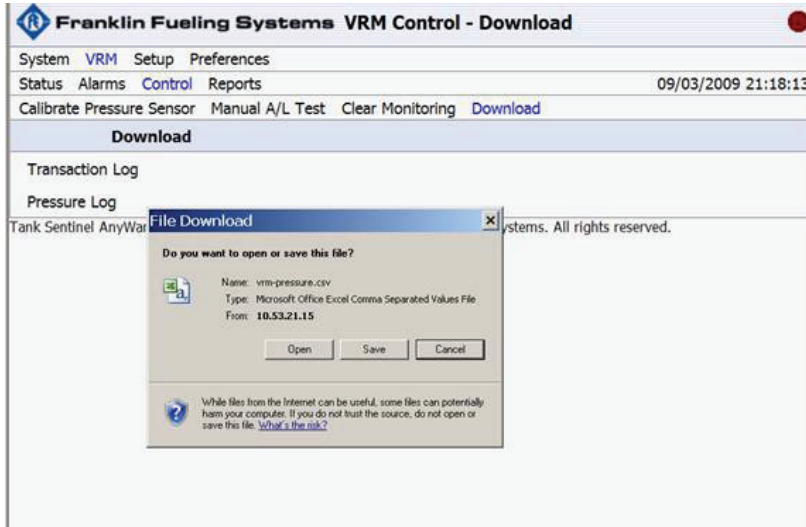

4. Once downloaded, the file can be opened by double clicking on it. The file is best viewed when Microsoft Excel is installed on the PC.

START-UP/NEW INSTALLATION FORM  
INCON VAPOR RECOVERY MONITORING (VRM) SYSTEM

DATE \_\_\_\_\_

## INCON VRM Startup Checklist

Service Company Name	Telephone Number
Service Technician	INCON Tech Cert #
Station Address	City
Phase I EVR Equipment Manufacturer	Phase II EVR Equipment Manufacturer

Dispenser Equipment Checklist		YES	NO	Initials
1	Franklin Fueling Systems, . Healy Phase II EVR System including ISD System installed according to CARB E.O. VR-202?			
2	Is the Vapor Pressure Sensor test port installed in the correct direction? When the ball valve is closed it should isolate the Vapor Pressure Sensor from the containment area. See Figure 11 of the procedure. If it is not then it must be configured such that the pressure sensor is isolated when the valve is closed.			
3	Is the Pressure Sensor in the Open position with the plug in the test port? See Figure 11 of the procedure.			
4	Was Oil and gasoline compatible PTFE Tape used on the threads for the Vapor Flow Meter rather than pipe dope?			
5	Was a pressure decay test run per TP201.3?			
6	Was the Dispenser Vapor Line Integrity Test run to check for leaks in the dispensing equipment?			

Tank Sentinel Equipment Checklist		YES	NO	Initials
7	Was the dispenser maximum load current measured and recorded? Be sure the proper size Relay Module is used. Use the 10A Relay Module if the current exceeds 2 Amps.			
8	Were the Gasoline Dispenser Hook Signals wired individually to the AC Input Module with dispenser 1 wired to the first set of channels? Verify all non-gasoline hook signals are installed after the last gasoline hook signal.			
9	Has the Administrator Password been set?			
10	Was the External ATG alarm able to be generated and cleared?			



# Appendix A: Alarm Codes

Device	Description	Category	Type	Definition	Possible Cause and Solution
Fueling Point [n]	Daily Vapor Collection or Weekly Vapor Collection <sup>1</sup>	VRM	Warning or Alarm	This Vapor Recovery alarm occurs when the vapors being return to the UST are blocked. The alarm will occur either at the end of the day or the end of the week depending on the type of vapor recovery system is installed.	May be caused by leaking hanging hardware, blocked hoses or vapor recovery lines, jammed flow meter. Run Exhibit 5 of VR-202 to verify a blockage. Check for leaks by viewing the vanes through the site glass on the VFM.
	Weekly or Monthly Ullage Pressure <sup>1</sup>	VRM	Warning or Alarm	This vapor recovery alarm occurs when the UST ullage pressure exceeds the alarm threshold for the time period specified in the alarm.	Look for problems using one or more of the following VR-202 procedures/ tests: Dispenser Integrity Test B-3m (i.e. "Plumbing Tightness test), Exhibit 4, Exhibit 5, Exhibit 9 (pressure sensor only) or flow rate verification per section 1.2.3.
	Weekly Ullage Pressure Leak Test <sup>1</sup>	VRM	Warning or Alarm	This vapor recovery alarm occurs when the Vapor Recovery Monitor determines a leak greater than the allowable.	May occur when there's an excessive leak in the vapor recovery containment area. Perform a pressure decay test per TP-201.3.
Channel [n]	Missing	VRM	Alarm	A flow meter is not connected or there is an open in the wiring. This will only occur for a flow meter channel that is programmed to have a flow meter.	Check the connection. Measure the voltage of the terminals, which should be approximately 18Vdc.
Channel [n]	Error	VRM	Alarm	The Vapor Recovery Monitor does not understand the data transmission.	This may happen when a channel is programmed for a magnostriptive probe but has a vapor flow meter connected instead.
	Pressure Sensor Open Circuit	VRM	Alarm	The pressure sensor is not connected to the Vapor Recovery Monitor.	Usually due to a bad connection or a broken wire. In some cases the sensor may not be working. First check the connections inside the dispenser junction box then at the Console terminal block. Second, measure the voltage at the terminal blocks and verify the voltage. See page 17.
	External TS-DIM Connection Down	VRM	Alarm	No communication between the TS-DIM and the Console.	Occurs with bad connection, TS-DIM does not have power, TS-DIM is not working. Check the wiring between the TS-DIM and the Console. Check the jumper settings in the TS-DIM, see installation manual.
	TS-DIM Read Data Error	VRM	Alarm	Bad communication to the Console.	Most likely a baud rate problem. Check the baud rate in the Console as well as the jumper settings in the TS-DIM.
	External ATG Connection Down	VRM	Alarm	No communication or bad communication between the ATG and the Console.	Check the comm. Port settings in both the ATG and the Console. These comm. Port settings should match. Make sure there is a straight serial cable between the ATG and the Console.
Printer	Check Thermal Printer	System	Warning	Printer is out of paper, or the printer door is open.	Make sure the printer has paper, and the printer door is closed completely.
	Printer Head Temperature	System	Warning	Print head high temperature (65°C) persists for at least 2 minutes.	Printer will resume printing and the alarm will clear after a short cool-down period. Keep the console area cool and ventilated. If the alarm does not clear, contact FFS Technical Support.
	Printer Paper Jam	System	Warning	Indicates that paper is jammed in the printer	Carefully lift printer cover to inspect and remove jammed paper.

Device	Description	Category	Type	Definition	Possible Cause and Solution
Slot [n]	[i] Module is offline, where <i>i</i> is the module number	System	Alarm	Occurs when a module is not communicating with the controller.	If RED LED is on or Green LED is blinking try cycling power.
	[i] Module number mismatch, where <i>i</i> is the module number	System	Alarm	Occurs when the number of modules does not match the programmed number of modules.	Check the setup at <b>System Configuration»Modules Expected</b> to see if the correct numbers are programmed.
	System Bus Error	System	Alarm	The communication bus is not working properly.	Check to see if a particular module has a red Error LED. If so try to trouble shoot the bad module. Also try removing the bad module and see if the alarm goes away.
TS-DTUn	Remote DTU is Offline	System	Alarm	A remote DTU is not communicating to the console DTU.	Wrong ID Number Dispenser Powered Off Not installed correctly Not on same phase voltage as console DTU
	Console DTU number mismatch	System	Alarm	The console DTU is not communicating with the console.	Bad bus connection Not powered
	DTU FFS Interference	System	Alarm	Two networks have the same Network ID	Change Network ID



3760 Marsh Road • Madison, WI 53718, U.S.A.  
Tel: +1 608 838 8786 • Fax: +1 608 838 6433  
Tel: USA & Canada 1 800 225 9787 • Tel: México 001 800 738 7610

**Franklin Fueling Systems GmbH**  
Rudolf-Diesel-Strasse 20 • 54516 Wittlich, GERMANY  
Tel: +49-6571-105-380 • Fax: +49-6571-105-510