

# ISD Vapor Flow Meter

## Installation Guide



# Notice

---

Veeder-Root makes no warranty of any kind with regard to this publication, including, but not limited to, the implied warranties of merchantability and fitness for a particular purpose.

Veeder-Root shall not be liable for errors contained herein or for incidental or consequential damages in connection with the furnishing, performance, or use of this publication.

Veeder-Root reserves the right to change system options or features, or the information contained in this publication as approved by ARB.

This publication contains proprietary information which is protected by copyright. All rights reserved. No part of this publication may be modified or translated to another language without the prior written consent of Veeder-Root.

Contact TLS Systems Technical Support for additional troubleshooting information at 800-323-1799.

## **DAMAGE CLAIMS / LOST EQUIPMENT**

Thoroughly examine all components and units as soon as they are received. If any cartons are damaged or missing, write a complete and detailed description of the damage or shortage on the face of the freight bill. The carrier's agent must verify the inspection and sign the description. Refuse only the damaged product, not the entire shipment.

Veeder-Root must be notified of any damages and/or shortages within 30 days of receipt of the shipment, as stated in our Terms and Conditions.

## **VEEDER-ROOT'S PREFERRED CARRIER**

1. Contact Veeder-Root Customer Service at 800-873-3313 with the specific part numbers and quantities that were missing or received damaged.
2. Fax signed Bill of Lading (BOL) to Veeder-Root Customer Service at 800-234-5350.
3. Veeder-Root will file the claim with the carrier and replace the damaged/missing product at no charge to the customer. Customer Service will work with production facility to have the replacement product shipped as soon as possible.

## **CUSTOMER'S PREFERRED CARRIER**

1. It is the customer's responsibility to file a claim with their carrier.
2. Customer may submit a replacement purchase order. Customer is responsible for all charges and freight associated with replacement order. Customer Service will work with production facility to have the replacement product shipped as soon as possible.
3. If "lost" equipment is delivered at a later date and is not needed, Veeder-Root will allow a Return to Stock without a restocking fee.
4. Veeder-Root will NOT be responsible for any compensation when a customer chooses their own carrier.

## **RETURN SHIPPING**

For the parts return procedure, please follow the appropriate instructions in the "General Returned Goods Policy" pages in the "Policies and Literature" section of the Veeder-Root **North American Environmental Products** price list. Veeder-Root will not accept any return product without a Return Goods Authorization (RGA) number clearly printed on the outside of the package.

## **FOR INSTALLATIONS IN THE STATE OF CALIFORNIA**

Please refer to the California Air Resources Board Vapor Recovery Certification Phase II EVR Executive Order web site ([www.arb.ca.gov/vapor/eo-evrphaseII.htm](http://www.arb.ca.gov/vapor/eo-evrphaseII.htm)) for the latest manual revisions pertaining to Executive Order VR202 (Healy Phase II EVR System Including ISD System).

©Veeder-Root 2013. All rights reserved.

## ISD Vapor Flow Meter Installation

Contractor Certification Requirements .....	1
Product Marking Information .....	2
Safety Warnings .....	3
Safety Precautions .....	4
Related Manuals .....	4
Before You Begin .....	4
Veeder-Root Parts .....	5
Tools Required .....	5
Installation Steps - Vacuum Assist System Above Shear Valve .....	6
Installation Steps - Vacuum Assist System Below Shear Valve .....	8
Seal and Connect Field Wiring .....	11

## Figures

Figure 1.	Example Vapor Flow Meter Installation Above Shear Valve .....	7
Figure 2.	Field wiring Vapor Flow Meter - Observe Polarity .....	8
Figure 3.	Example flow meter installations with approximate clearances .....	9
Figure 4.	Example Vapor Flow Meter Installation Below Shear Valve .....	10
Figure 5.	Epoxy sealing field wiring .....	11
Figure 6.	Connecting Vapor Flow Meter to TLS-350 Smart Sensor Interface Module .....	12
Figure 7.	Connecting Vapor Flow Meter to TLS-450 USM Module .....	12

# ISD Vapor Flow Meter Installation

This manual contains instructions to install a Veeder-Root ISD (In-Station Diagnostic) Vapor Flow Meter in a dispenser's vapor return line in vacuum assist systems.

This manual assumes all preliminary site preparation is completed, and that wiring from the console to the Vapor Flow Meter junction box is in place and meets the requirements set out in the applicable console Site Prep and/or TLS RF Wireless 2 system (W2) installation manuals.

## Contractor Certification Requirements

Veeder-Root Contractor Certification Requirements	Installer Certification <sup>6</sup>	ATG Technician Certification <sup>7</sup>	VR Vapor Products Certification <sup>8</sup>
Install <sup>1</sup> ISD	X	X	X
Install PMC	X	X	X
Install CCVP	X	X	X
Install Wireless ISD/PMC	X	X	X
Installation Checkout <sup>2</sup>		X	X
ATG Startup <sup>3</sup> / Training <sup>4</sup> / Service <sup>5</sup>		X	X
ISD Startup / Training / Service			X
PMC Startup / Training / Service			X
CCVP Startup / Training / Service			X
Wireless ISD/PMC Startup / Training / Service			X
Install Pressure Sensor (ATG)	X	X	X
Maintain Pressure Sensor (ATG)		X	X
Calibrate Pressure Sensor (ATG)		X	X
Clear ATG Pressure Sensor Alarm (ATG)		X	X
Clear ISD/PMC Alarms (ISD/PMC)			X
<sup>1</sup> Perform wiring and conduit routing; equipment mounting <sup>2</sup> Inspect wiring and conduit routing; equipment mounting <sup>3</sup> Turn power on, program and test the systems <sup>4</sup> Provide supervised field experience in service techniques and operations <sup>5</sup> Troubleshoot and provide routing maintenance		<sup>6</sup> UST Monitoring Systems – Installer (Level 1) <sup>7</sup> Certified UST Monitoring Technician <sup>8</sup> VR Vapor Products	

**Warranty Registrations** may only be submitted by selected Distributors. Certified installers are required to provide the GDF operator with the completed Equipment Warranty Notice, form 577013-868, for their records.

## Product Marking Information

### RELATED DOCUMENTS

#### Documents Required to Install Equipment



This intrinsically safe apparatus is only for use as part of a Veeder-Root Automatic Tank Gauging System (ATG Console with probes and sensors). To install intrinsically safe apparatus, use the specific control drawing that appears on the nameplate of the applicable associated apparatus (ATG Console):

Equipment	UL/cUL Control Drawing Document No.
<b>Associated Apparatus</b>	
TLS-450/8600	331940-008
TLS-350, TLS-350R	331940-011
<b>Intrinsically Safe Apparatus for Wireless Applications</b>	
Tank Gauge Accessories	331940-012

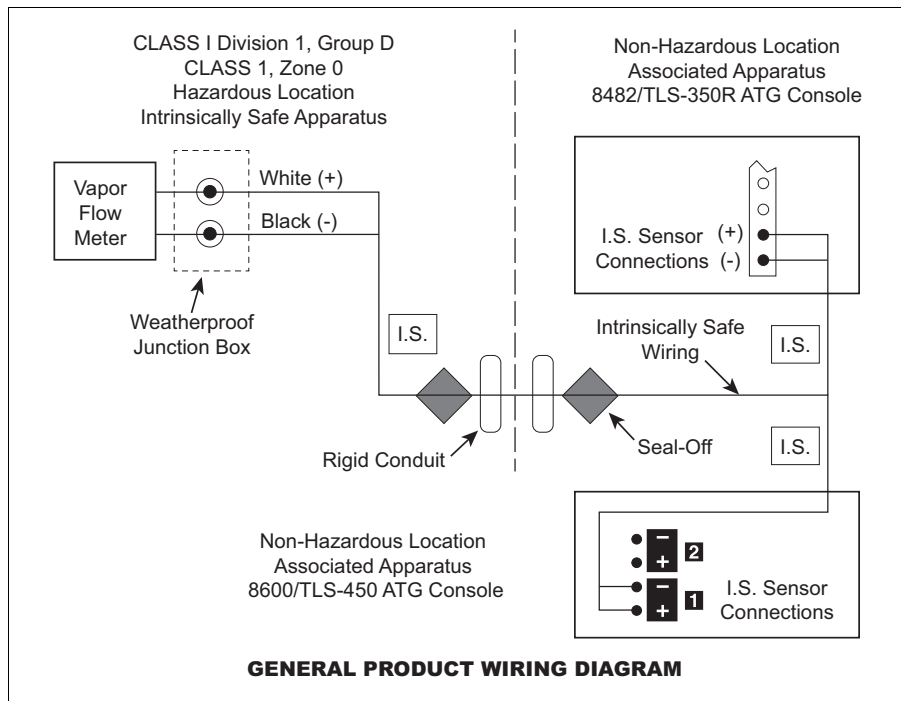
The control drawings contain information related to the correct installation of the overall intrinsically Safe System. This includes information such as maximum number of apparatus, specific apparatus allowed in the system, maximum cable lengths, references to codes, proper grounding and so on. Control drawings can be found on the accompanying Compact Disk (TECH DOCS CD) or on the internet at [veeder.com](http://veeder.com) under SUPPORT; VR TECHNICAL DOCUMENTS; DRAWINGS.









**Product Label Contents**

	<b>VEEDER-ROOT</b> TM	I.S. CIRCUIT FOR HAZLOC SENSOR	
			F/N 331847-XXX
	CL I, DIV. 1, GP.D		S/N XXXXXX
	CL I, ZONE 0		
	AEx ia IIA	-40°C ≤ Ta ≤ +60°C	
	Ex ia IIA		
	TC=T4	MANUAL NO. 577013-796	
	SECURITE INTRINSEQUE		

**Safety Warnings**

To protect yourself and your equipment, observe the following warnings and important information:







 **WARNING**

    	<p><b>This product is to be installed in systems operating near locations where highly combustible fuels or vapors may be present.</b></p> <p><b>FAILURE TO COMPLY WITH THE FOLLOWING WARNINGS AND SAFETY PRECAUTIONS COULD CAUSE DAMAGE TO PROPERTY, ENVIRONMENT, RESULTING IN SERIOUS INJURY OR DEATH.</b></p> <ol style="list-style-type: none"> <li>1. Read and follow all instructions in this manual, including all safety warnings to protect yourself and others from serious injury, explosion, or electrical shock.</li> <li>2. Comply with all applicable codes including: the National Electrical Code; federal, state, and local codes; and other applicable safety codes.</li> <li>3. To protect yourself and others from being struck by vehicles, block off your work area during installation or service.</li> <li>4. Do not alter or modify any component or substitute components in this kit.</li> <li>5. <b>Warning!</b> Substitution of components may impair intrinsic safety.</li> <li>6. Field wiring to the Flow Meter must not share a conduit with any non-intrinsically safe device's wiring</li> <li>7. <b>Warning!</b> To prevent ignition of flammable or combustible atmospheres, disconnect power before servicing.</li> <li>8. Materials used in the construction of this device contain aluminum. Care must be taken to avoid ignition hazards due to impact or friction.</li> <li>9. Before installing or taking the unit into a hazardous area, earth the unit in a safe area to remove any static charge. Then immediately transport the unit to the installation site. Do not rub or clean the unit prior to installation. Cleaning is not required under normal service conditions. Do not rub or clean the unit after installation. If the unit is not fixed to a known earth point when installed, ensure that a separate earth connection is made to prevent the potential of a static discharge. When fitting or removing the unit, use of anti-static footwear or clothing is required.</li> </ol>
--	--

**NOTE** Failure to install this product in accordance with its instructions and warnings will result in voiding of all warranties with this product.

## Safety Precautions

The following safety symbols may be used throughout this manual to alert you to important safety hazards and precautions.

 <p><b>EXPLOSIVE</b> Fuels and their vapors are extremely explosive if ignited.</p>	 <p><b>FLAMMABLE</b> Fuels and their vapors are extremely flammable.</p>
 <p><b>ELECTRICITY</b> High voltage exists in, and is supplied to, the device. A potential shock hazard exists.</p>	 <p><b>TURN POWER OFF</b> Live power to a device creates a potential shock hazard. Turn Off power to the device and associated accessories when servicing the unit.</p>
 <p><b>READ ALL RELATED MANUALS</b> Knowledge of all related procedures before you begin work is important. Read and understand all manuals thoroughly. If you do not understand a procedure, ask someone who does.</p>	 <p><b>USE SAFETY BARRICADES</b> Unauthorized people or vehicles in the work area are dangerous. Always use safety cones or barricades, safety tape, and your vehicle to block the work area.</p>

## Related Manuals

- 576013-879 TLS-3XX Series Consoles Site Prep Manual
- 577013-879 TLS-450 Series Consoles Site Prep Manual
- 577013-800 In-Station Diagnostics Install, Setup & Operation Manual
- 577013-964 TLS RF Wireless 2 System (W2) Installation and Maintenance Guide

## Before You Begin

- A level 1 or higher certified Veeder-Root Technician must be available (on site) to assist in this type of installation.
- Comply with all recommended safety practices identified by OSHA (Occupational Safety and Health Administration) and your employer.
- Follow all installation requirements as per NFPA (National Fire Protection Association) 30, 30A, and 70.
- Review and comply with all the safety warnings in the installation manuals and any other national, State or Local requirements.
- When directly wiring to a TLS console, a 2-conductor, 18 AWG shielded cable must be installed in intrinsically safe conduit from each dispenser to the intrinsically safe wiring compartment of the TLS console.
- Debris from plumbing modifications should be flushed through the piping system prior to installing the ISD Vapor Flow Meter.
- Use only UL classified Gas/TFE yellow teflon tape on all fittings. Do not use pipe dope to seal pipe threads or fittings in and out of the ISD Vapor Flow Meter.

## Veeder-Root Parts

---

- Veeder-Root ISD Vapor Flow Meter (P/N 331847-001).
- Sensor Installation Kit, see Table 1.

**Table 1.- Vapor Flow Meter Installation Kit (P/N 330020-445)**

Item	Qty.	Description	P/N
1	1	ISD Vapor Flow Meter	331847-002
2	2	Flange with 1" NPT threaded hole	332091-001
3	4	5/16-18 UNC-2B x 3/4" hex head bolt	514100-426
4	2	1-11.5 NPT x 2 " male to male threaded steel nipple	576008-655
5	1	Inlet filter	332092-001
6	1	Outlet o-ring (Parker size # 2-218, Nitrile)	512700-258
7	1	Cord grip group	331028-001
8	1	Sealing pack	514100-304
9	2	Wire nut	576008-461
10	2	Tie wrap	510901-337
11	4	5/16" Lock washer	514100-436

## Tools Required

---

1. Pipe wrench suitable for tightening 1-inch NPT pipe.
2. 1/2" socket wrench to install Vapor Flow Meter flange bolts.
3. Necessary pipe fitter's equipment and a non-hazardous work space suitable to modify dispenser vapor line for Vapor Flow Meter installation, when necessary.



## Installation Steps - Vacuum Assist System Above Shear Valve



1. Before installing this device, turn Off, tag/lock out power to the system, including console and submersible pumps.
2. Remove the dispenser's lower sheet metal doors to access the vapor plumbing.
3. Loosen any factory installed mounts and/or brackets necessary to provide room to disconnect the vacuum motor outlet plumbing.
4. Disconnect the factory installed plumbing between the outlet of the vacuum motors and the field installed plumbing above the vapor shear valve, if present (see example installation in Figure 1). Retain the manufacturers installed piping for later use.
5. Remove any unneeded field installed plumbing above the vapor shear valve. The Vapor Flow Meter with flanges attached can be used for sizing the required head space of approximately 8 inches. Approximately 3 inches of clearance is required on both sides of the piping to accommodate the width of the meter body.
6. Working through the vacuum motor mounting plate, if present, connect the upper flange to factory installed plumbing. Note that this may need to be temporarily suspended across the vacuum motor mounting plate while the lower plumbing work progresses.
7. Install any plumbing and the lower flange that will connect between the outlet side of the Vapor Flow Meter and the shear valve or lower vapor return line. Note: Elbows should be kept to a minimum (straight vertical plumbing is preferable). To improve efficiency and to reduce the risk of liquid traps, all horizontal plumbing must be pitched to drain.
8. Clean all debris around the inlet and outlet plumbing prior to installing the Vapor Flow Meter. Do not blow compressed air through the Vapor Flow Meter to prevent damaging the internal screens.
9. Install the o-ring into the lower mounting flange.
10. Taking care that foreign material (chips, debris, sealant, etc.) does not enter the open piping or Vapor Flow Meter, carefully insert the inlet filter and then connect the Vapor Flow Meter to the upper flange. Note that the flow arrow on the side of the meter body must point down.
11. Connect the lower flange to the Vapor Flow Meter.
12. Tighten any loose fittings and hardware
13. Route the wiring to the TLS RF transmitter (W2) or into the junction box via the supplied cord grip assembly when direct wiring to a TLS console.
14. Connect the wires from the Vapor Flow Meter to the field wiring from the console and cap with wire nuts (see Figure 2). Not required when connecting to the TLS RF transmitter (W2).
15. After all other ISD Vapor Flow Meters and the ISD Pressure Sensor are installed, pressurize the tank ullage space and vapor piping to at least 2 inches WC and test for leaks using leak detection solution.

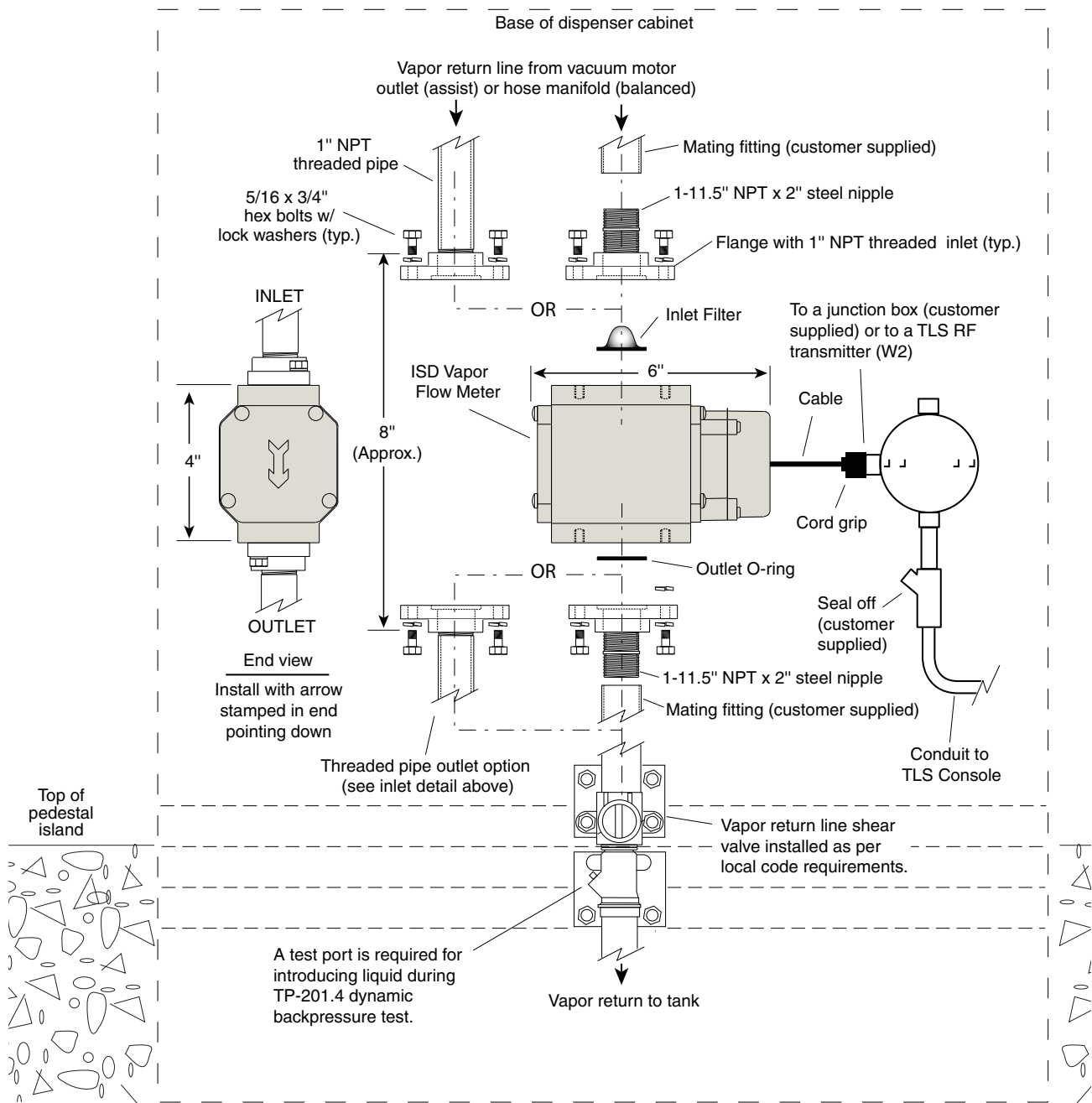

Figure 1. Example Vapor Flow Meter Installation Above Shear Valve

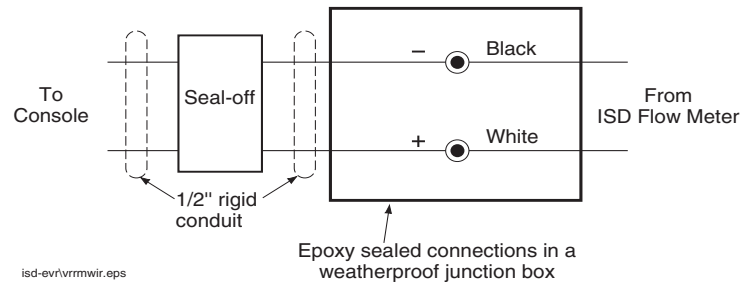

Figure 2. Field wiring Vapor Flow Meter - Observe Polarity

## Installation Steps - Vacuum Assist System Below Shear Valve

**NOTE: The Vapor Flow Meter should be installed prior to setting the dispenser in place or prior to installing any vacuum assist retrofit kits. If retrofitting the vacuum assist system, follow all manufacturer's instructions.**



1. Before installing this device, turn Off, tag/lock out power to the system, including console and submersible pumps.
2. Remove the dispenser's lower sheet metal doors to access the vapor plumbing, if necessary.
3. If a retrofit vacuum assist kit will be installed, remove any hardware specified in the manufacturer's installation instructions. Do not install the retrofit assembly at this time.
4. Remove any unneeded field installed plumbing between the vapor shear valve and the vapor return line fitting. Figure 3 shows two example installations of the Vapor Flow Meter with the required lateral or wye fitting for running the TP-201.4 back pressure test. Approximately 3 inches of clearance is required on both sides of the piping to accommodate the width of the meter body.
5. Connect the lower flange to the pipe that is connected to the lateral or wye access fitting (see Figure 4).
6. Install the Vapor Flow Meter over the lower flange.
7. Connect the upper flange with serviceable screen above the Vapor Flow Meter.
8. Using a close nipple, thread the shear valve into the upper flange.
9. Install the vacuum assist retrofit kit, if required, following the retrofit kit manufacturer's installation instructions - or fit the dispenser to its permanent mounting points.
10. Using nipples, unions, and other plumbing as required, connect the vacuum assist outlet to the shear valve.
11. Route the wiring into the junction box via the supplied cord grip assembly. Connect the wires from the Vapor Flow Meter to the field wiring from the console and cap with wire nuts (see Figure 2) - OR - connect the wires to the TLS RF transmitter (W2).
12. After all other ISD Vapor Flow Meters and the ISD Pressure Sensor are installed, pressurize the tank ullage space and vapor piping to at least 2 inches WC and test for leaks using leak detection solution.

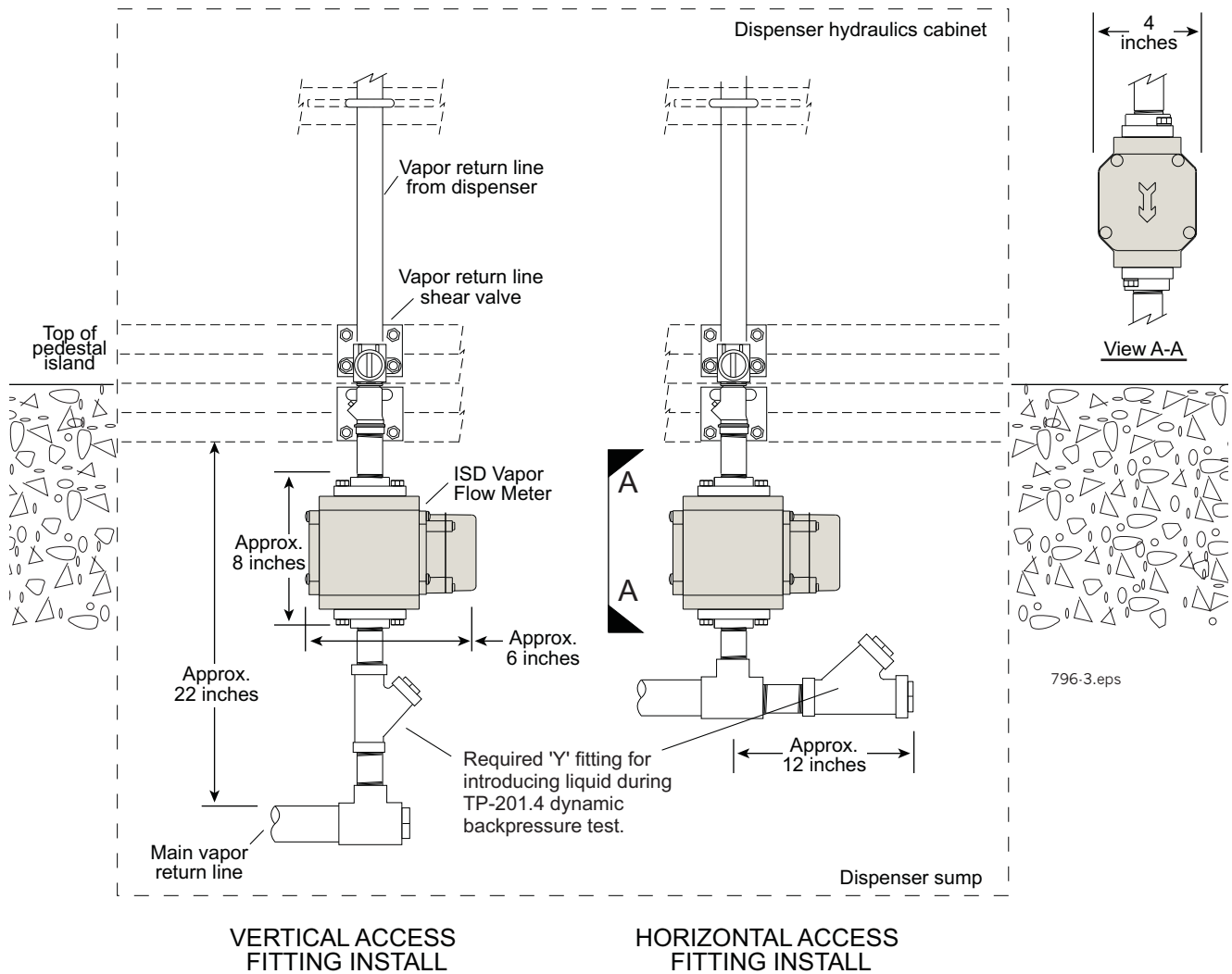

Figure 3. Example flow meter installations with approximate clearances

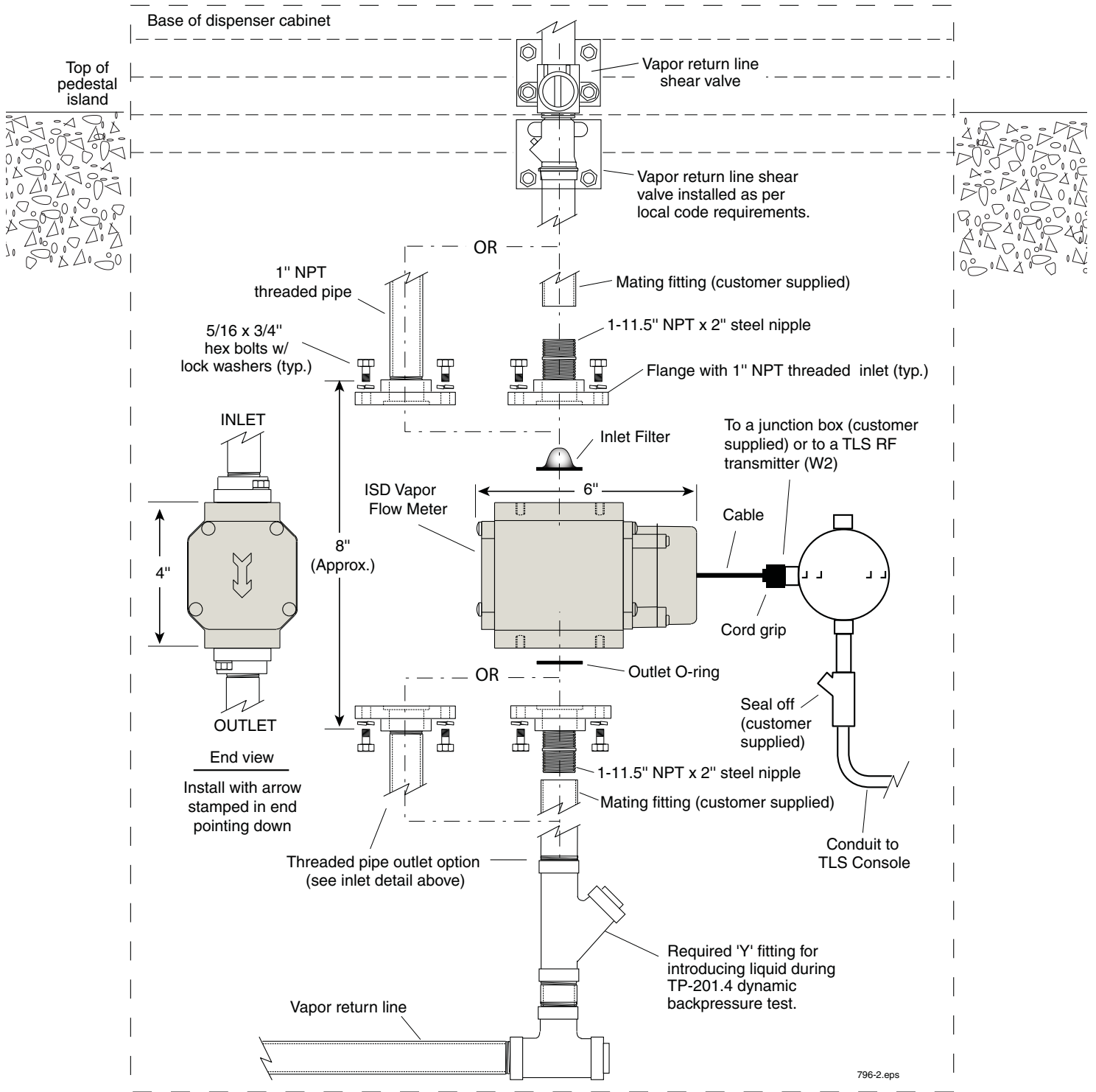

Figure 4. Example Vapor Flow Meter Installation Below Shear Valve

## Seal and Connect Field Wiring

1. Seal wire nuts with epoxy sealant following the instructions in Figure 5. Note - wire sealing is not required for installations using a wireless interface.



**CAUTION:** Epoxy sealant is irritating to eyes, respiratory system, and skin. Can cause allergic skin reaction. Contains: epoxy resin and Cycloaliphatic epoxy-carboxylate. Precautions: Wear suitable protective clothing, gloves, eye, and face protection. Use only in well ventilated areas. Wash thoroughly before eating, drinking, or smoking.

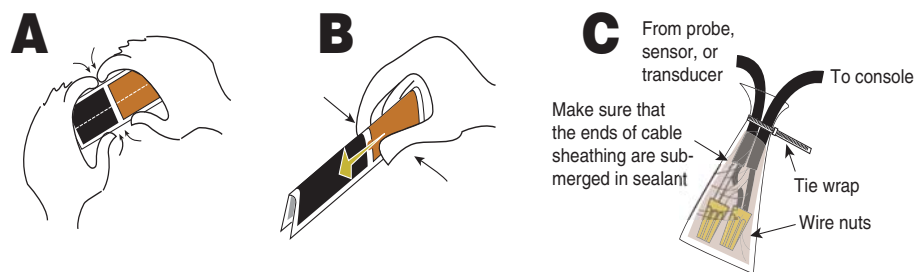

**Instructions:**

NOTE: When temperature is below 50°F (10°C), keep resin in a warm place prior to mixing (e.g., in an inside pocket next to body).

1. Open epoxy sealant package, and remove resin pak.
2. Holding resin pak as shown in A, bend pak along long length.
3. As shown in B, firmly squeeze the RED SIDE of the resin, forcing it through the center seal and into BLACK SIDE.

4. Mix thoroughly to a uniform color by squeezing contents back and forth 25-30 times.
5. Squeeze mixed, warm resin into one end of bag and cutoff other end.
6. Slowly insert wiring connections into sealing pack until they fit snugly against the opposite end as shown in C.
7. Twist open end of bag and use tie wrap to close it off and position the tie wrapped end up until the resin jells.

consoles/epoxy2w.eps

Figure 5. Epoxy sealing field wiring

2. Push the epoxy sealed bag into the junction box. Replace and tighten the junction box cover.
3. Terminate field wiring into TLS-350 Consoles and connect to Smart Sensor Module located in the intrinsically safe wiring compartment as shown in Figure 6. Terminate field wiring into TLS-450 Consoles and connect to USM Module located in the module bay of the console as shown in Figure 7. Note: you must observe polarity! Also, the cable length between the console and sensor must not exceed the distance stated in the appropriate console's Site Prep manual. For the wireless version, terminate the wires in the TLS RF transmitter (W2).

Note: Intrinsically safe devices must be installed in accordance with Article 504 of the National Electrical Code, ANSI/NFPA 70, for installation in the United States, or Section 18 of the Canadian Electrical Code for installations in Canada.

4. Replace the lower sheet metal doors in the dispenser.

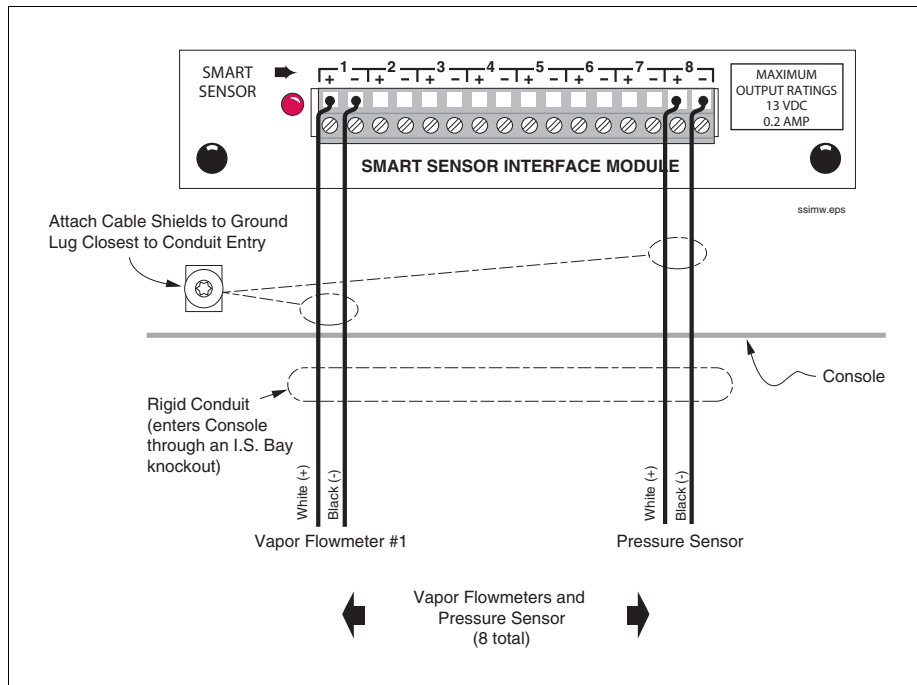

Figure 6. Connecting Vapor Flow Meter to TLS-350 Smart Sensor Interface Module

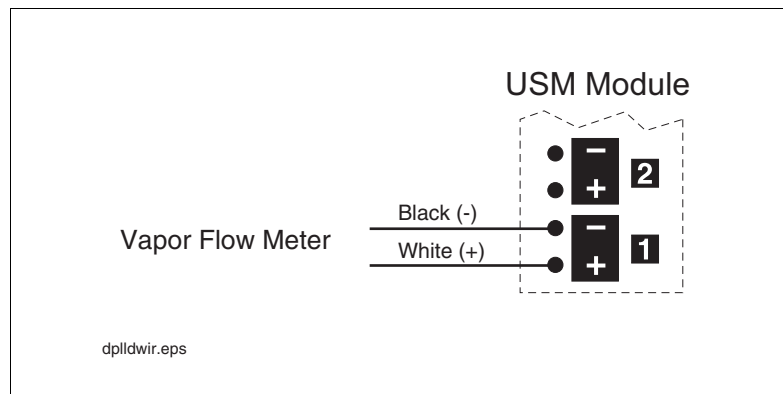

Figure 7. Connecting Vapor Flow Meter to TLS-450 USM Module



**NOTE!** For wireless configurations, see TLS RF System Control Drawing 331940-012.

